

SC500(1790)
Computerized Control
System for Square
Buttonhole Machine

Version: 2013-01

Forewords





Thank you for using our Computerized Control System for Buttonhole Machine.

It is appreciated that you do read this manual carefully in order to operate the machine correctly and effectively. If the user operates the machine contrary to regulations herein, thus causes losses to user or third party, we will not take any responsibility. Besides that, you should keep this manual for future use. For any fault or problem of machine, please ask the professionals or the technicians authorized by us for repair service.













Safety Matters for Attention

1. Signs & Definitions of Safety Marks

This User's Manual and the Safety Marks printed on the products are for you to use this product correctly so as to be away from personal injury. The signs and definitions of Marks are shown at below:

 Danger	Danger: The incorrect operation due to negligence will cause the serious personal injury or even death.
 Caution	Caution: The incorrect operation due to negligence will cause the personal injury and the damage to mechanism
	This kind of marks is "Matters for Attention", and the figure inside the triangle is the content for attention. (Exp. The left figure is "Watch Your Hand!")
	This kind of mark is "Forbidden".
	This kind of mark means "Must". The figure in the circle is the contents that have to be done. (Exp. The left figure is "Ground!")

2. Safety Matters for Attention

 Danger	
	For opening the control box, please turn off the power and take away the plug from socket firstly, and then wait for at least 5 minutes before opening the control box. Touching the part with high voltage will cause the personal injury.
 Caution	
Usage Environment	
	Try not to use this sewing machine near the sources of strong electronic disturbance like (high-frequency welding machine). The source of strong electronic disturbance will affect the normal operation of the sewing machine.
	The voltage fluctuation shall be within $\pm 20\%$ of the rated voltage. The large fluctuation of voltage will affect the normal operations of sewing machine, and the regulator will be needed in that circumstance
	Working temperature: $5^{\circ}\text{C}\sim 35^{\circ}\text{C}$. The operation of the sewing machine will be affected by environment with temperature beyond the above range.
	Relative Humidity: 45%~85 % (No dew inside the machine), or the operation of sewing machine will be affected.
	The supply of the compressed gas should be over the consumption of the sewing machine. The insufficient supply will be cause the abnormal operation of the machine.
	In case of thunder, lightning or storm, please turn off the power and pull plug out the socket. Because these will have the influence on the operation of sewing machine
Installation	
	Please ask the trained technicians to install the sewing machine.
	Don't connect machine to power supply until the installation is finished. Otherwise the action of sewing machine may cause personal injury once the start switch is pressed by mistake.
	When you tilt or erect the head of sewing machine, please use both of your hands in that operation. And never press the sewing machine with strength. If the sewing machine loses its balance, it will fall into floor thus causes the personal injury or mechanical damage.

















	Grounding is a must. If the grounding cable is not fixed, it may cause the electric-shock and mis-operation of machine
	The entire cables shall be fixed with a distance at 25mm away from the moving component at least. By the way, don't excessively bend or tightly fixed the cable with nails or clamps, or it may cause the fire or electric shock.
	Please attach the safety cover at the head.
Sewing	
	This sewing machine can only be used by the trained staff.
	This sewing machine has no other usages but the sewing.
	When operating the sewing machine, please remember to put on the glasses. Otherwise, the broken needle will cause the personal injury.
	At following circumstances, please cut off the power at once so as to avoid the personal injury caused by the mis-operation of start switch: 1. Threading; 2. Replacement of needles; 3. The sewing machine is left unused or beyond supervision
	At working, don't touch or lean anything on the moving components, because both of the above behaviors will cause the personal injury or the damage to the sewing machine
	During working, if the mis-operation happens or the abnormal noise or smell is found at the sewing machine, user shall cut off the power at once, and then contact the trained technicians or the supplier of that machine for solution.
	For any trouble, please contact the trained technicians or the supplier of that machine.
Maintenance & Inspection	
	Only can the trained technicians perform the repair, maintenance and inspection of this sewing machine.
	For the repair, maintenance and inspection of the electrical component, please contact the professionals at the manufacturer of control system in time.
	At following circumstances, please cut off the power and pull off the plug so as to avoid the personal injury caused by the mis-operation of start switch: 1.Repair, adjustment and inspection ; 2. Replacement of the consumptive devices, like needle, knife and so on.
	Before checking, adjusting and repair any air-driven equipment, user needs cut off the source of gas and wait for the pressure indicator drop to "0".
	If you have to adjust the machine when the power is on, you can't be too careful at following the entire Safety Matters for Attention
	If the sewing machine damages due to the unauthorized modification, our company will not be responsible for it.

Table of Content

1 General Information	1
1. 1 General.....	1
1. 2 Function and Specification	1
1. 3 Standardization	2
1. 4 Matters for Safe Using.....	2
1. 5 The Preventions on Instruction	4
1. 6 Operation Method.....	5
1. 7 Sewing List.....	6
2 Preparation before Sewing.....	7
2. 1 Installation of Needle.....	7
2. 2 Threading (Needle Thread).....	7
2. 3 Installation of Bobbin	8
2. 4 Threading at Bobbin	9
2. 5 Adjustment of Bobbin Thread Tension.....	9
2. 6 Installation of Knife.....	10
2. 7 Method for Adding Oil	12
3 Operating Instruction.....	13
3. 1 Name and Description of Each Part.....	13
3. 2 Common Buttons	14
3. 3 Basic Operation	14
3. 4 Operation of Normal Pattern.....	15
3. 5 Operation of Continuous Sewing.....	17
3. 6 Operation of Cyclic Sewing.....	19
4 Normal Pattern Sewing.....	22
4. 1 Function Keys.....	22
4. 2 Pattern Registration	25
4. 3 Pattern Copy	27
4. 4 Pattern Naming	28
4. 5 Threading.....	28
4. 6 Winding	29
4. 7 Select the Type of Presser	30
4. 8 Pattern Selection	31
4. 9 Sewing Shape Selection.....	32
4. 10 Sewing Data Setting	34
4.11 Direct Selection of Pattern	42
4.12 Trial Sewing.....	42
4.13 Set Needle Thread Tension	44
4. 14 Operation of Counter	45
4. 15 Emergency Stop.....	46
4. 12 VDT Pattern Operation.....	47
4. 12. 1 Display and Operation of VDT Pattern.....	47
4. 12. 2 Sewing Data of VDT Pattern	48

5	Continuous Sewing.....	49
5.1	Function List.....	49
5.2	Edition of Continuous Sewing.....	50
5.2.1	Selection of Continuous Sewing Pattern.....	50
5.2.2	Edition of Continuous Sewing Pattern.....	50
5.2.3	Continuous Sewing Pattern Registration.....	53
5.2.4	Continuous Sewing Pattern Copy.....	54
5.2.5	Deletion of Continuous Sewing Pattern.....	55
5.3	Continuous Sewing Interface.....	58
5.3.1	Function List.....	58
5.3.2	Trial Sewing for Continuous Sewing.....	59
6	Cyclic Sewing.....	62
6.1	Function List.....	62
6.2	Edition of Cyclic Sewing.....	63
6.2.1	Pattern Registration.....	63
6.2.2	Pattern Copy.....	64
6.2.3	Selection of Cyclic Sewing Pattern.....	65
6.2.4	Edition of Cyclic Sewing Pattern.....	65
6.2.5	Change Fabric.....	67
6.3	Cyclic Sewing Interface.....	68
6.3.1	Function List.....	68
6.3.2	Trial Sewing at Cyclic Sewing.....	70
7	Mode Setting.....	72
7.1	Function List.....	73
7.2	Level 1 Parameter Setting.....	74
7.3	Level 2 Parameters Setting.....	78
7.4	Counter Setting.....	81
7.4.1	Functions.....	82
7.5	Settings on User Management.....	83
7.6	Edition of Sewing Data.....	84
7.7	Change Sewing Mode.....	85
7.8	Register Pattern to Direct Button.....	85
7.9	Test Mode.....	87
7.10	Brightness Adjustment.....	92
7.11	Operation of Keyboard Lock.....	92
7.12	Initialization.....	94
7.13	Parameter Back-up & Restoration.....	96
8	Communication.....	98
8.1	About the Available Data.....	98
8.2	Operations.....	98
8.3	Pattern Transfer.....	99
8.4	Parameter Transfer.....	101
8.5	Software Update.....	102
9	Information.....	104

9. 1 Check the Maintenance Information.....	104
9. 2 Set the Maintenance Time	106
9. 3 Method to Release the Warning	107
9. 4 Information of Production Control	108
9. 4. 1 Via Information Interface.....	108
9. 4. 2 Via Sewing Interface.....	109
9. 4. 3 Setting of Production Control Information	110
9. 5 Threading Figure	113
9. 6 Warning Record	114
9. 7 Running Record.....	115
9. 8 Setting of Periodical Password	116
10 Appendix 1.....	124
10. 1 Warning List	124
10. 2 Hint List.....	125
10. 3 Common Problems and Solutions.....	127
10. 4 Default Values of Sewing Shapes	130
11 Appendix 2.....	139
11. 1 Installation Size of Control Box	139
11. 2 Installation Size of Operation Panel	140
12. 3 System Diagram.....	141

1 General Information

1.1 General

This computerized control system for sewing machine features the following advantages: 1) Adoption of the world leading AC servo control technology on main shaft motor provides high torque, good efficiency, stable speed and low noise; 2) Diversified design of control panel can meet the special requirement of users on attachment; 3) System adopts German style structure, which offers easy installation and maintenance to users; 4) The system control software can be updated via the remote communication, which is easy for user to improve the performance of machine.

1.2 Function and Specification

For the functions and parameters of this computerized control AC servo system, please refer to table 1:

Table 1: Functions and Parameters

Name of Controller	High-speed Square Buttonhole Machine
Width	5mm (Min: 0.05mm)
Size of Knife(Length)	6.4~31.8mm (1/4"~11/4")
Sewing Length (Max)	41mm (The Max size is at 120mm with optional device)
Sewing Speed	Standard 3600rpm Max 4200rpm
Speed Control Method	Input via Control Panel
Needles	DP×5 # 11J ~ # 14J
Stroke of Needle Bar	34.6mm
Threading Bar	Chain-style Threading Bar
Shuttle	Type DP, All-auto Rotation Oil-supply Shuttle
Presser Height	14mm (Customized Setting) Max 17mm(At contrary rotation)
Presser Driving Device	Pulse Motor (1 pedal· 2 pedals)
Winding	Build-in Type (only winding at machine running)
Cloth-feeding Driving Device	Pulse Motor
Swing Needle Driving	Pulse Motor
Knife Driving Device	Two-way Solenoid
Upper-thread Tension Function	Solenoid Tension Method User can set the data at control panel to adjust each part (Parallel Part, Doubling Part Tension)
Stitch Form	Angle, Radial, Round (Selected at Control Panel) and other 30 types
Patterns in Memory	500 Patterns
Memory Media	U Disk
1/2 Shift	Can be set at every pattern

Input Voltage	AC175V~AC265V
Motor	Small AC Servo Motor 400W Direct Driving
Size	Width 200mm、Height 360mm、Length 570mm
Head Weight	70Kg

Presser Specification:

	Presser 1	Presser 2	Presser 3	Presser 5
Width	4mm	5mm	5mm	3-6mm(Set at will)
Sewing Length (Max)	25mm	35mm	41mm	10-120mm (Set at will)

Specification of Models S: Standard K: Knitting

1.3 Standardization

The button using the common figure can be understood by the users from different countries.

1.4 Matters for Safe Using

● Working Environment

Do not use this control device in the following environments:

- Power Voltage
 - ◆ Voltage fluctuation beyond $\pm 10\%$ of the standard voltage.
 - ◆ Capacity of power supply doesn't meet the requirement
- Electrical Disturbance
 - ◆ Beside the wave launcher with strong electrical wave and magnetic field or the high cyclic machine
- Temperature/ Humidity
 - ◆ Temperature below 0°C or above 50°C
 - ◆ Outdoors or the area directly shined by sun
 - ◆ Beside stove (heater).
 - ◆ Relating humidity below 5% or above 95% or the area without dew
- Air
 - ◆ Dusty area or area with corrosive gas
 - ◆ Area that is easy to have air explosion or oil explosion
- Vibration
 - ◆ If the location of the sewing machine usually has excessive vibration, please move the control box to other place.

● Installation

- Control Box
 - ◆ Please install the control box according to the instruction
- Attachments

- ◆ If other attachments are needed, please turn off the power and pull off the power plug.
- Power Cable
 - ◆ Do not press power cable with force or excessively twist power cable.
 - ◆ The power cables shall be fixed with a distance at 25mm away from the rotating component at least.
 - ◆ Before powering the control box, user shall carefully check the voltage of power supply and position of power input on control box. If the power transformer is used, user should also check it before powering the machine. At this moment, the power switch of sewing machine must be set as “Off”.
- Grounding
 - ◆ In order to avoid the noise disturbance and shock caused by electrical leakage, user should ground the grounding cable.
- Attachments
 - ◆ If the electrical attachments are needed, please connect them to the proper positions.
- Disassemble
 - ◆ When removing the control box, user should turn off the power and pull off the power plug.
 - ◆ At pulling off the power plug, user should hold the plug and remove it, instead of pulling the power cable only.
 - ◆ The control box contains the dangerous high voltage power. For opening the control box, please turn off the power and take away the plug from socket firstly, and then wait for at least 5 minutes before opening the control box.

● Maintenance, Inspection and Repair

- Only can the trained technicians perform the repair and maintenance of this machine.
- When replacing the needles and shuttles, user has to turn off the power.
- Please use the spare parts from the authorized manufacturers

● Others

- Do not touch the rotating or moving part of the machine, especially the needle and belt, when the machine is working. User should also keep his/her hair away from those moving parts, so as to avoid the danger.
- Do not drop the control device on the floor, nor insert ant stuff into the slot on the control box.
- Do not run the machine without the cover shells
- If this control device is damaged or unable to work normally, please ask the technicians to adjust or repair it. Do not run the machine when the problem is not solved
- Please do not change or modify the control device without authorization

● Abandonment



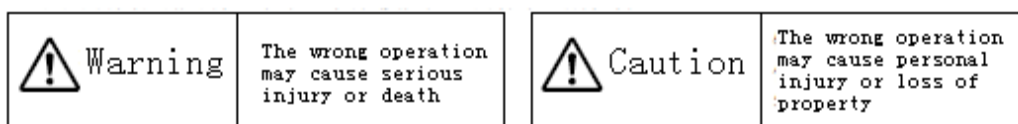

- Dispose it as common industrial trash.

● Warning and Danger

- The mistake operation may cause danger. For the serious level, please refer to the figure at below:



■ The meaning of the figure are shown at below:.

	Please operate machine according to instruction		Caution: High Voltage
	Caution: High Temperature		Grounding is a must
	Never do this.		

1.5 The Preventions on Instruction

Warning

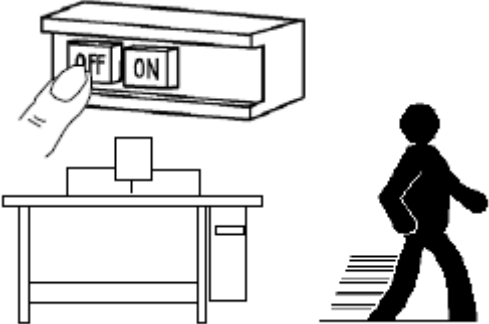
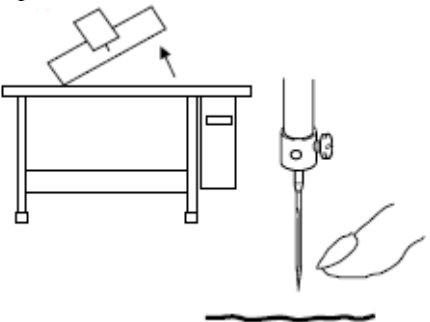
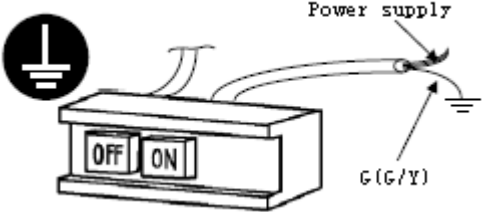
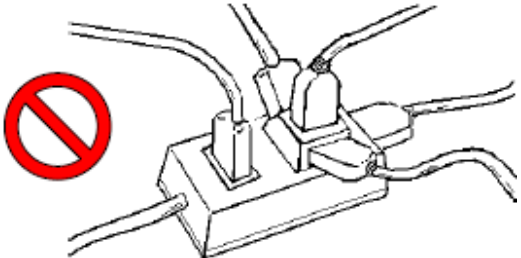
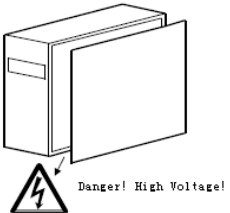
<p>1、 When you leave the machine, please turn it off.</p> 	
<p>3、 If user needs tilt the head or replace the needle or thread the Needle thread, please turn off the power</p> 	<p>4、 Grounding the machine with ground cable</p> 
<p>5、 Do not use the household terminal block to let machines to share one power supply</p> 	<p>6、 For opening the control box, please turn off the power and take away the plug from socket firstly, and then wait for at least 5 minutes before opening the control box</p> 

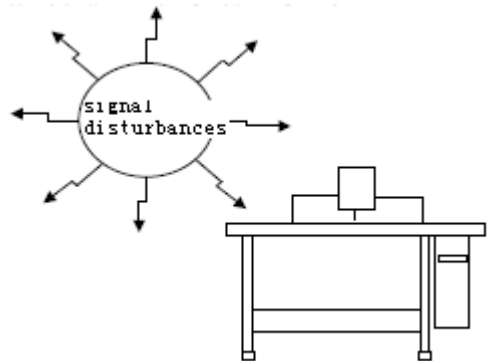
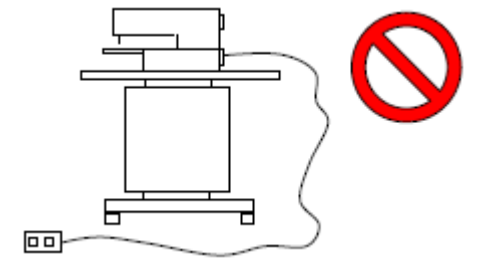
<p>8、 Please keep it away from the machine creating the high cyclic disturbance</p> 	<p>9、 If user needs the external signal socket to connect the attachments, the connecting wire shall be as short as possible. The long cable may cause the wrong operation. And the connection cable shall be the isolated cable</p> 
<p>10、 If the fuse is burnt, please solve the problem before replacing a new one with same capacity</p>	

1.6 Operation Method

We use the advanced touching operation technique on the operation panel, whose friendly interface and simple operation will bring the big changes to users in their usage. Users can finish the relating operations by using their fingers or other object to touch the screen.

The function keys include Ready Key, Information Key, Mode Key and Communication Key. For the specific operation, please refer to the chapters at below:

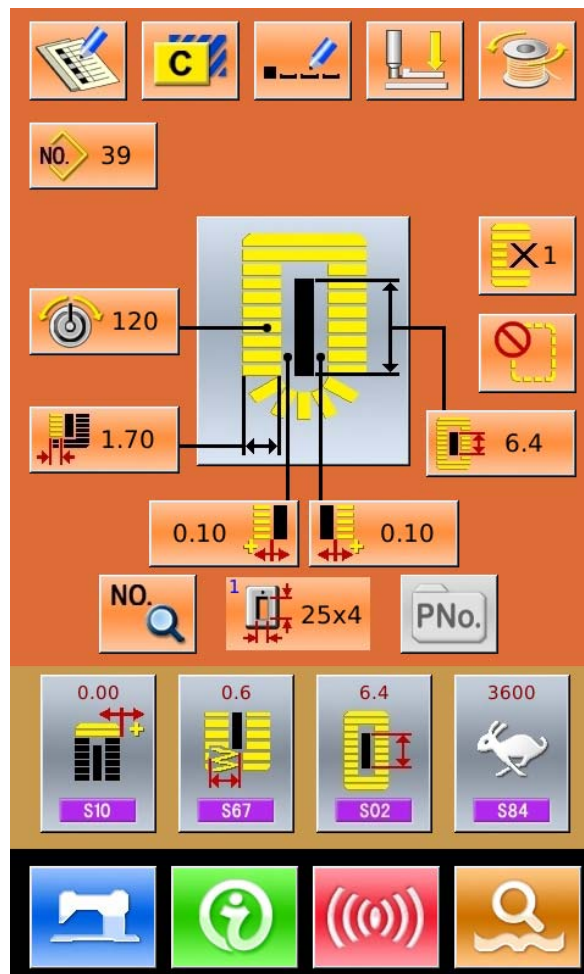





















Warning.

Never use sharp object to touch the screen, otherwise the touching panel will suffer the permanent damage.

1.7 Sewing List

01 Square 	02 Round 	03 Radial Square 	04 Radial 	05 Radial Straight Bar-tacking 
06 Radial Taper Bar-tacking 	07 Eyelet Square 	08 Eyelet Radial 	09 Eyelet Straight Bar-tacking 	10 Eyelet Taper Bar-tacking 
11 Semi-lunar 	12 Round Square 	13 Semi-lunar Square 	14 Semi-lunar Straight Bar-tacking 	15 Semi-lunar Taper Bar-tacking 
16 Eyelet Semi-lunar 	17 Eyelet Round 	18 Square Radial 	19 Square Semi-lunar 	20 Square Round 
21 Square Straight Bar-tacking 	22 Square Taper Bar-tacking 	23 Radial Semi-lunar 	24 Radial Round 	25 Semi-lunar Radial 
26 Semi-lunar Round 	27 Bar-tacking 	28 Bar-tacking Right Cut 	29 Bar-tacking Left Cut 	30 Bar-tacking Center Cut 

2 Preparation before Sewing

2.1 Installation of Needle



Caution!

In order to avoid the personal injury caused by the sudden start of machine, user has to turn off power and make sure the motor stops before performing the following operation

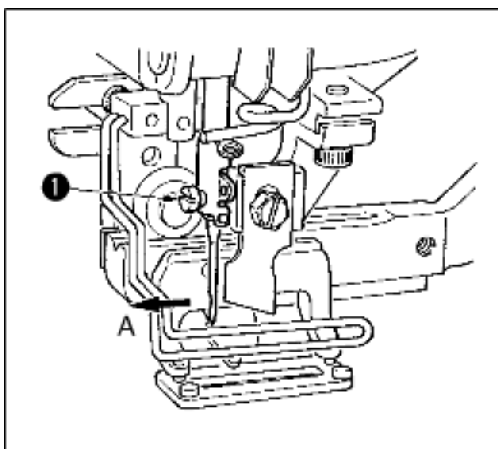

- 1) Turn the wheel to lift the needle to the highest position.
 - 2) Turn the slot on the needle to the front (in Direction A).
 - 3) Insert the needle into the needle bar hole deeply.
 - 4) Fix the needle screw ①
- ※ The needle should be DP×5 # 11J ~ # 14J

Do turn off power when you install needles.

2.2 Threading (Needle Thread)



Caution!

In order to avoid the personal injury caused by the sudden start of machine, user has to turn off power and make sure the motor stops before performing the following operation

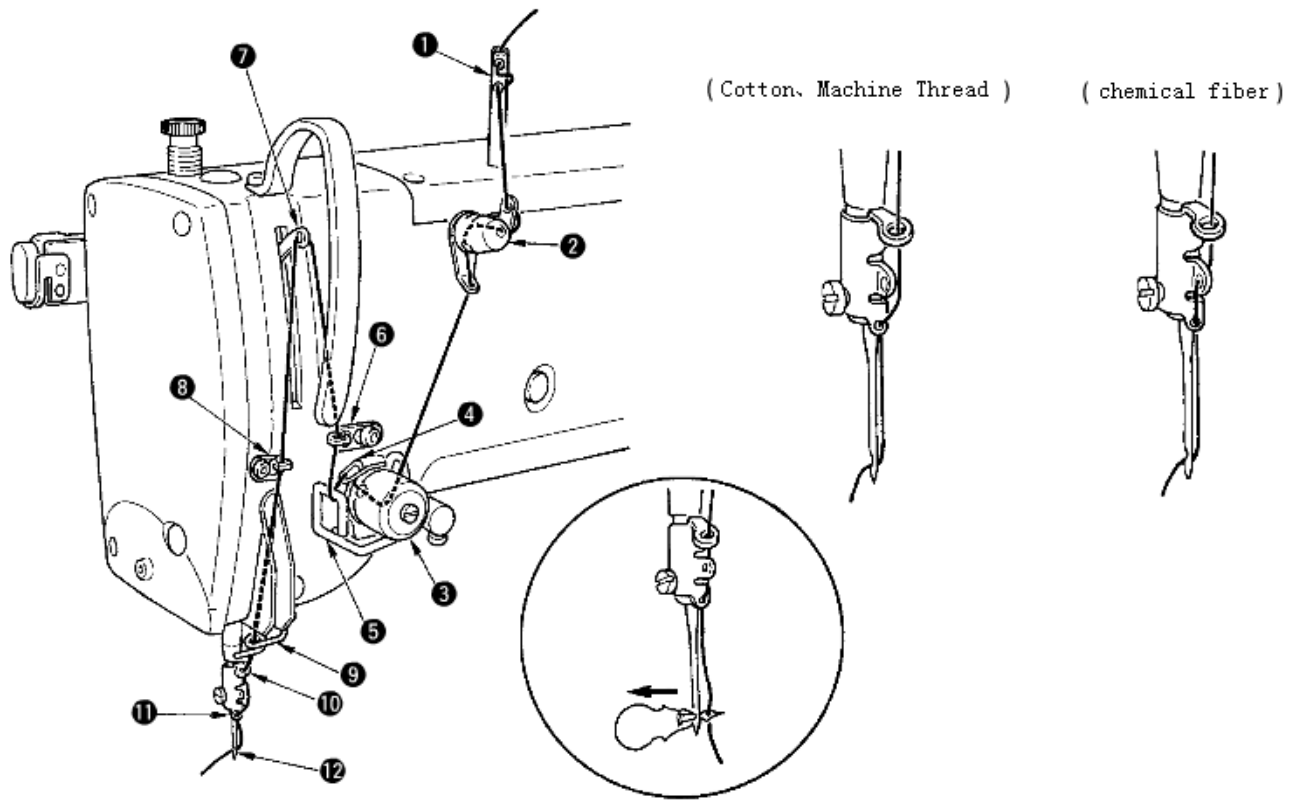

As shown in the picture above, please follow the steps from 1 to 12.

At threading, the threading device can help user to d this job in an easy and fast way.

2.3 Installation of Bobbin

 <p>Caution!</p>	<p>In order to avoid the personal injury caused by the sudden start of machine, user has to turn off power and make sure the motor stops before performing the following operation</p>
--	---

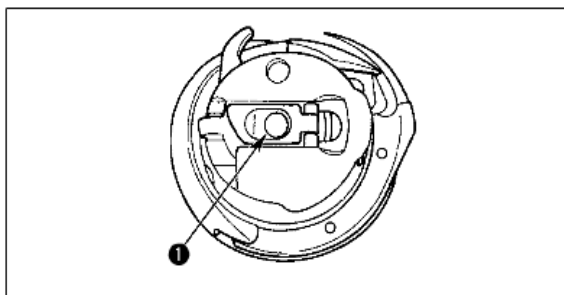

- ① Erect the bobbin handle
- ② Insert the bobbin shaft ① and close the handle. When the bobbin is pressed to the certain position, user will hear “Crack” at machine.
- ※ **If the bobbin is not in the proper position, the shuttle core will move at sewing and thread will be wound to shaft**
- ※ **The shape of standard shuttle is different from that of Non-oil shuttle. They cannot be used in common.**

2.4 Threading at Bobbin



Caution!

In order to avoid the personal injury caused by the sudden start of machine, user has to turn off power and make sure the motor stops before performing the following operation

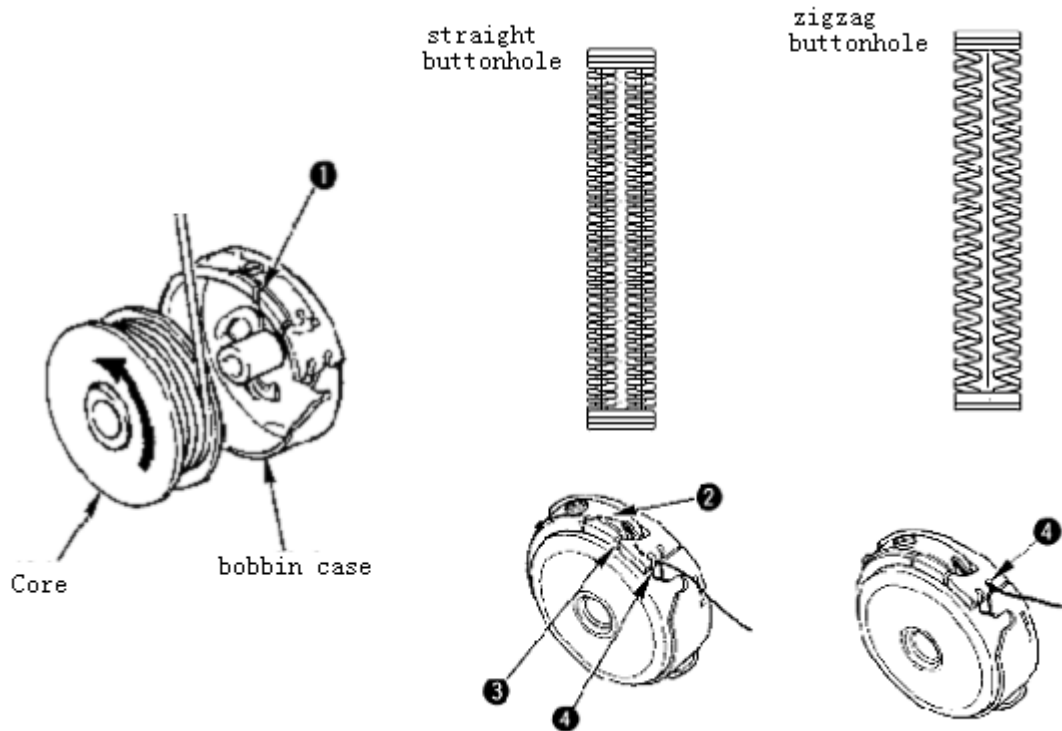

- 1) Install the shuttle core into the case in the direction of the arrow;
- 2) Thread the thread through the threading open ① and then pass the spring ②, then go through the open ③. Finally, pull the thread from the slot ④.

※ **Attention: The threading method at slot ④ in straight buttonhole sewing is different from that of zigzag buttonhole.**

2.5 Adjustment of Bobbin Thread Tension



Caution!

In order to avoid the personal injury caused by the sudden start of machine, user has to turn off power and make sure the motor stops before performing the following operation

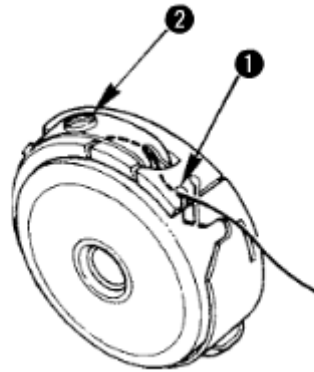

When the threading open ① is at up position, user need pull out the bobbin thread upward and adjust the tension in the way below:

Straight Buttonhole	0.05~0.15N	Hold and swing the thread from bobbin case, the case will go down slightly.
Zigzag Buttonhole	0.15~0.3N	Hold and shake the thread from bobbin case with strength, the case will go down.

Turn the tension screw ② to right to increase the bobbin thread tension, to left to decrease the tension.

※ When the chemical thread is used, please decrease the tension slightly; increase the tension when the cotton thread is used.

※ After adjusting the bobbin thread tension, user also needs to check the needle thread tension in the sewing parameters.

2.6 Installation of Knife

	Caution! In order to avoid the personal injury caused by the sudden start of machine, user has to turn off power and make sure the motor stops before performing the following operation
---	---

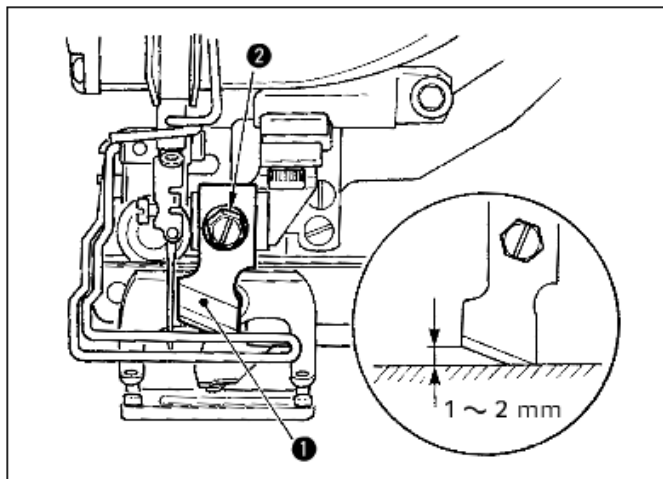

- 1) Remove the knife screw ② to disassemble the knife ① and shim.
- 2) Press the knife and adjust the distance from the knife to the needle plate to 1~2mm as shown in the picture at above. Then install the shim and fix the screw.

If the size of the knife is printed in British size, please refer to the table at below:

Size of Knife (displayed in British size and relating metric size)

Size of Knife (British size)	Size of Knife (metric size) mm
1/4	6.40
3/8	9.50
7/16	11.10
1/2	12.70
9/16	14.30
5/8	15.90
11/16	17.50
3/4	19.10
13/16	20.60
7/8	22.20
1	25.40
1 1/8	28.60
1 1/4	31.80
1 3/8	34.90
1 1/2	38.10

2.7 Method for Adding Oil



Caution!

In order to avoid the personal injury caused by the sudden start of machine, user has to turn off power and make sure the motor stops before performing the following operation

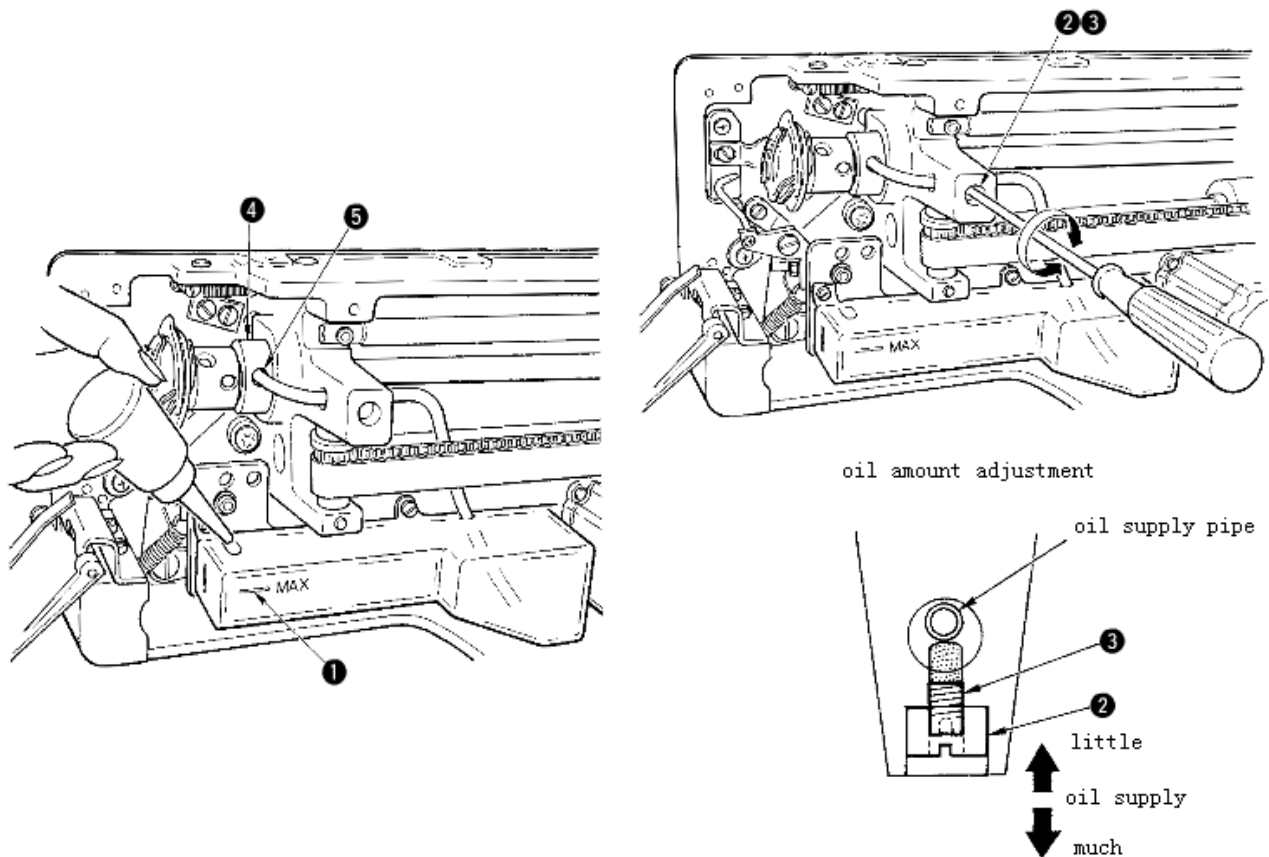

1) Add oil to tank

- Add oil until the oil surface reach the mark of MAX ①.

2) Adjustment of Oil Amount

- Release the fixing screw ② and adjust the Oil Adjustment Screw ③.
- At adjusting the oil amount, fix the Oil Adjustment Screw ③ to decrease the oil amount.
- After adjusting the oil amount, please fix the screw ②.
- If the sewing machine is a new one or left unused for long time, please disassemble the bobbin case and add oil for 2~3 drops. Additionally, add oil to the metal part ④ through the oiling hole ⑤ with several drops to wet the felt inside.

3 Operating Instruction

3.1 Name and Description of Each Part

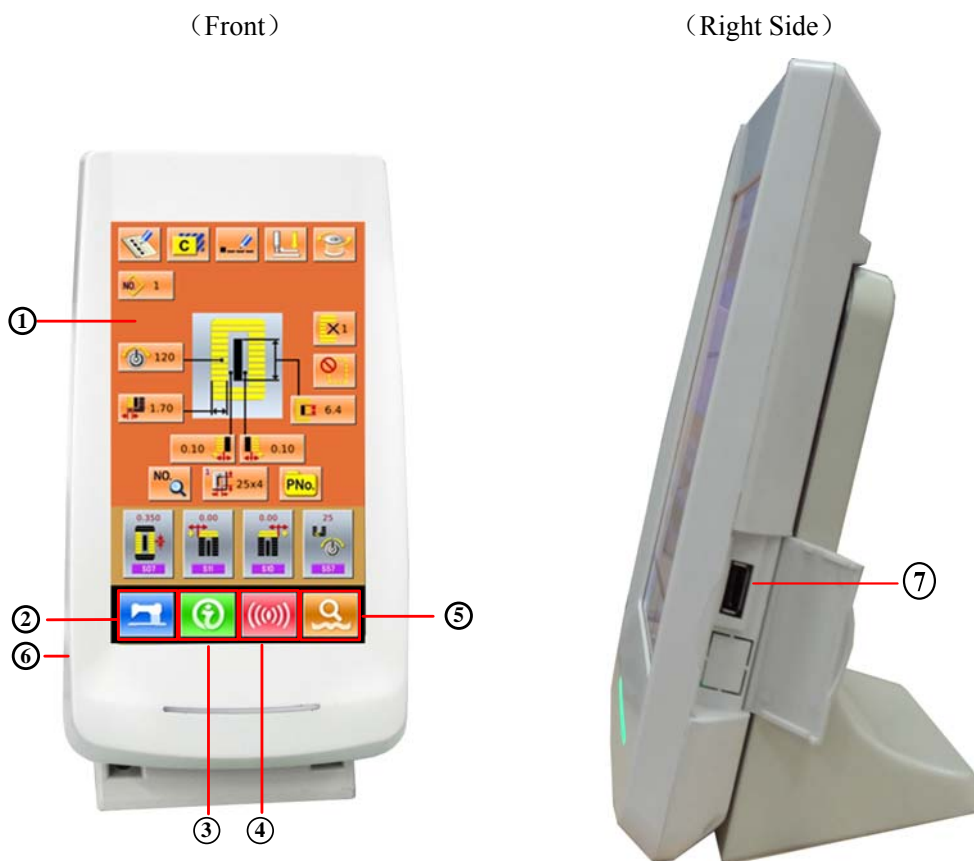

① Touch Panel • LCD Displayer

②  READY Key → Shift between the data input interface and sewing interface

③  Information Key → Shift between the data input interface and information interface

④  Communication Key → Shift between the data input interface and communication interface







⑤  Mode Key → Shift between the data input interface and communication interface

⑥ Cable

⑦ USB Port

3.2 Common Buttons

The buttons for the common operation in each interface are shown at below:

No.	Figure	Functions	Remarks
1		ESC → Quit the current interface. At data change interface, it is for cancelling the change of data.	
2		Enter → Confirm the changed data.	
3		Plus → Increase the value	
4		Minus → Decrease the value	
5		Reset → Release the Error	
6		Number Input → Display the number keyboard and input the number.	

3.3 Basic Operation

① Turn on the power

First, make sure that the set presser type (A) is the same as that of the presser actually installed.

② Select the wanted pattern No.

When the power is on, the data input screen is displayed. Pattern No. (Button B) which is marked at present is displayed in the upper section of the screen. Press Button B to select the pattern No. (The unregistered Pattern No. will not be displayed)

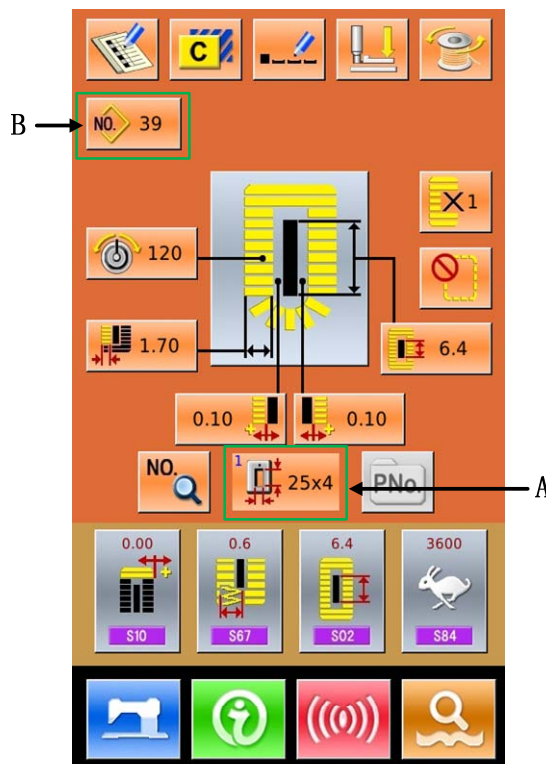

③ Set machine to Ready Sewing Status

Press READY key . The back-light of LCD displayer changes to blue color and the machine is ready for sewing. Area A is to set the speed and Area B is to display the customer management.

④ Start sewing

Set the sewing product to the presser position; operate the pedal to start the sewing machine, and sewing starts.

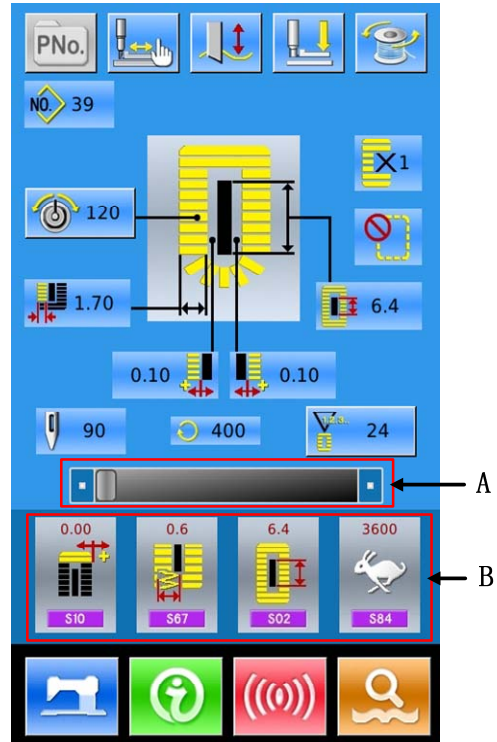

3. 4 Operation of Normal Pattern

The interface for setting and sewing the normal pattern is shown at right. For the function of each button, please refer to “4. Normal Pattern Sewing”.

The normal sewing is the default sewing mode in the system, which is also the initial mode of the system.



Steps of Operation:

- ① Press  to enter the Mode Setting



② Press  to select the normal sewing mode



③ Press  and then press  to display the main interface of Normal Sewing

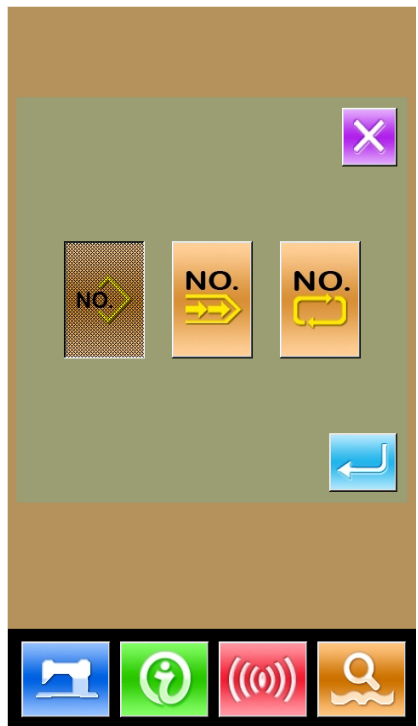

- ④ Select the sewing pattern
- ⑤ Set the necessary sewing parameter
- ⑥ Select the presser type
- ⑦ Perform the necessary editing operation (Registration, copy, naming and so on)

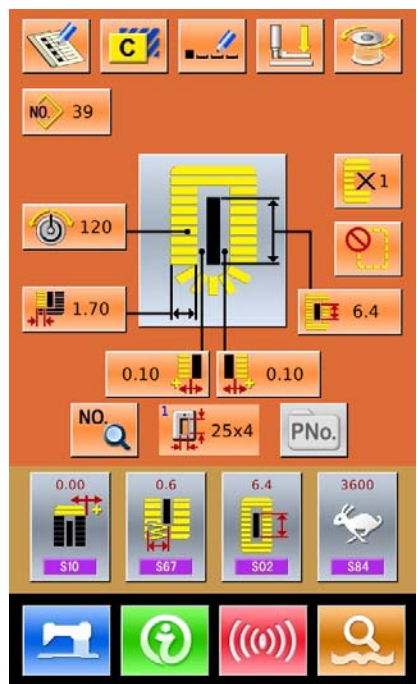

- ⑧ Press  to enter the sewing interface for sewing
- ⑨ Set knife and speed at sewing interface
- ⑩ Set the counter
- ⑪ Select the Trial Sewing if necessary
- ⑫ Drop the presser, step the pedal and start sewing

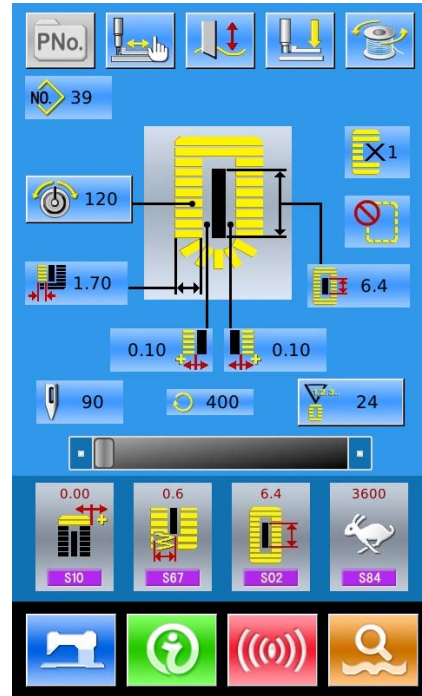





3.5 Operation of Continuous Sewing

The interface for the continuous sewing is shown at right. For the function of each button, please refer to “5. Continuous Pattern Sewing”.

Operation Steps:

- ① Press  to enter the Mode Setting



- ② Press  then select 
- ③ Press  and then press  to display the main interface of continuous sewing

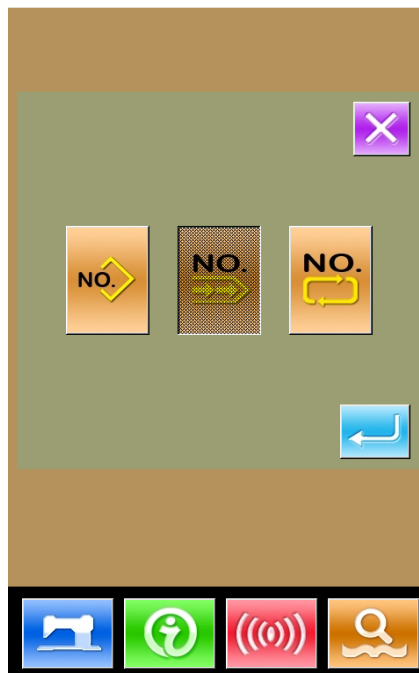

- ④ In the main interface of continuous sewing, please add the pattern used and the cloth-feeding amount.
- ⑤ Perform the necessary editing operations (Copy, Naming, Adding and Deletion)

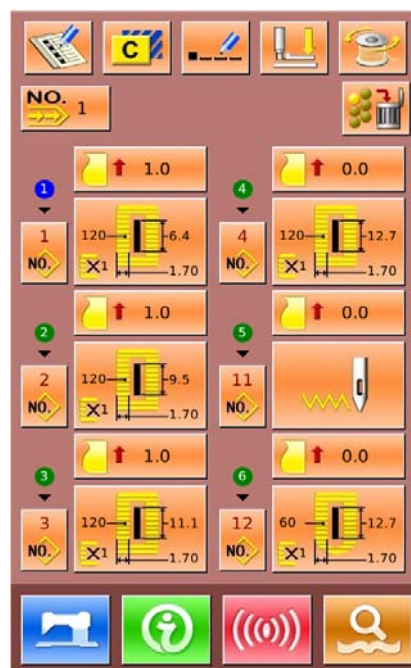

- ⑥ Press  to enter the sewing interface for sewing
- ⑦ Set knife and speed at sewing interface
- ⑧ Set the counter
- ⑨ Select the Trial Sewing if necessary
- ⑩ Drop the presser, step the pedal and start sewing

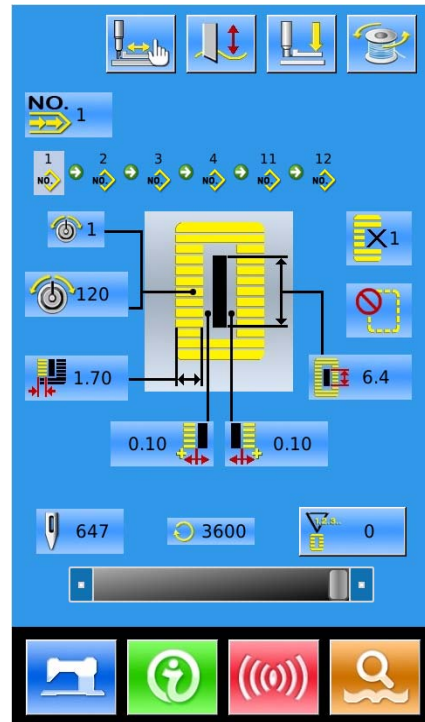





3.6 Operation of Cyclic Sewing

The interface for the cyclic sewing is shown at right. For the function of each button, please refer to “6. Cyclic Pattern Sewing”.

Operation Steps:

- ① Press  to enter the Mode Setting



- ② Press  then select 
- ③ Press  and then press  to display the main interface of cyclic sewing

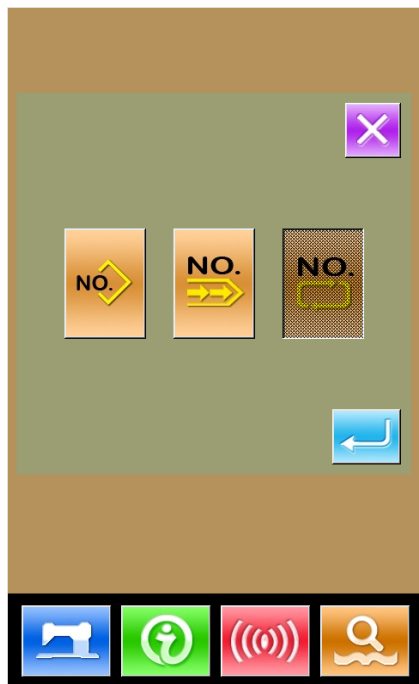

- ④ In the main interface of cyclic sewing, please select the fabric
- ⑤ Move the sewing position and add the pattern for cyclic sewing
- ⑥ Set the parameter of the pattern
- ⑦ Perform the necessary editing operations (Copy, Naming, Adding and Deletion)



- ⑧ Press  to enter the sewing interface for sewing
- ⑨ Set knife, tension and speed at sewing interface
- ⑩ Set the counter
- ⑪ Select the Trial Sewing if necessary
- ⑫ Drop the presser, step the pedal and start sewing

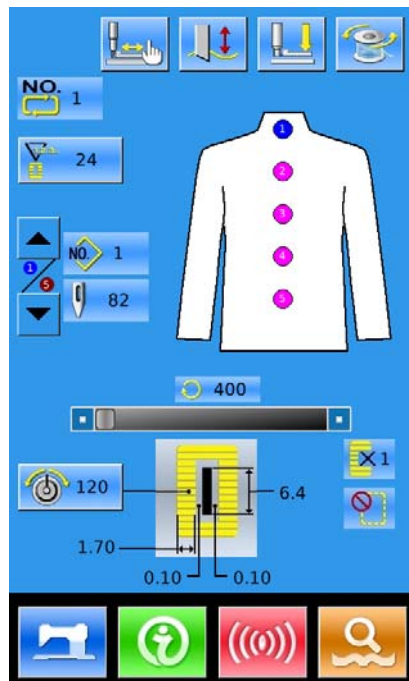

4 Normal Pattern Sewing

When the system is sold, the default mode in it is the normal pattern sewing mode. The operation steps of it are described in “3. Operation Instruction”. In this chapter, we will give the detailed description on this mode.



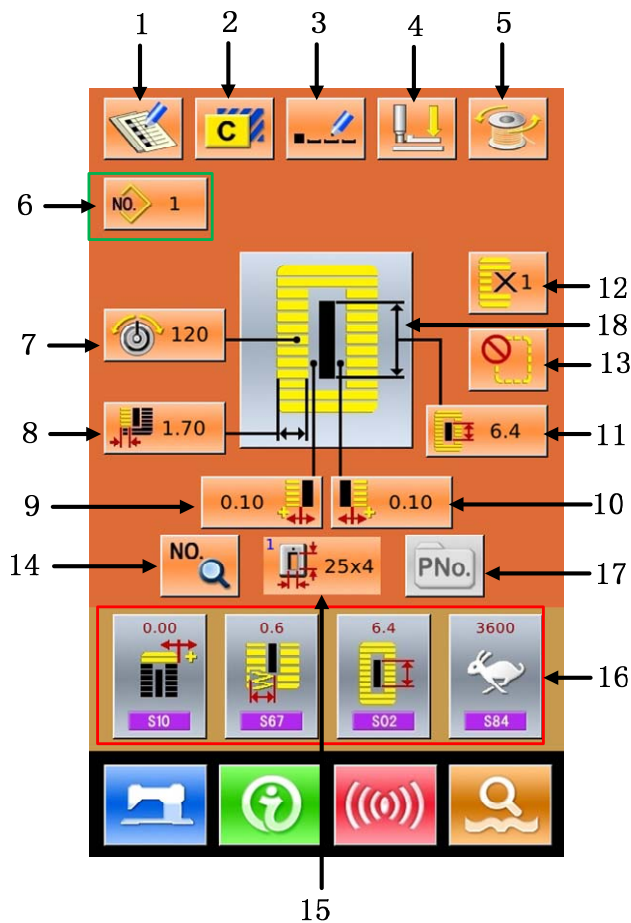

4.1 Function Keys

(1) Interface for Inputting Sewing Data

The interface of data input is shown as the Figure at right. For the detailed functions, please take the Function Key List for reference.



Function Key List:

No.	Figure	Function	Remarks
1		Pattern Registration	
2		Pattern Copy	
3		Pattern Naming	
4		Threading (Lower the presser foot)	User can change needle in this status







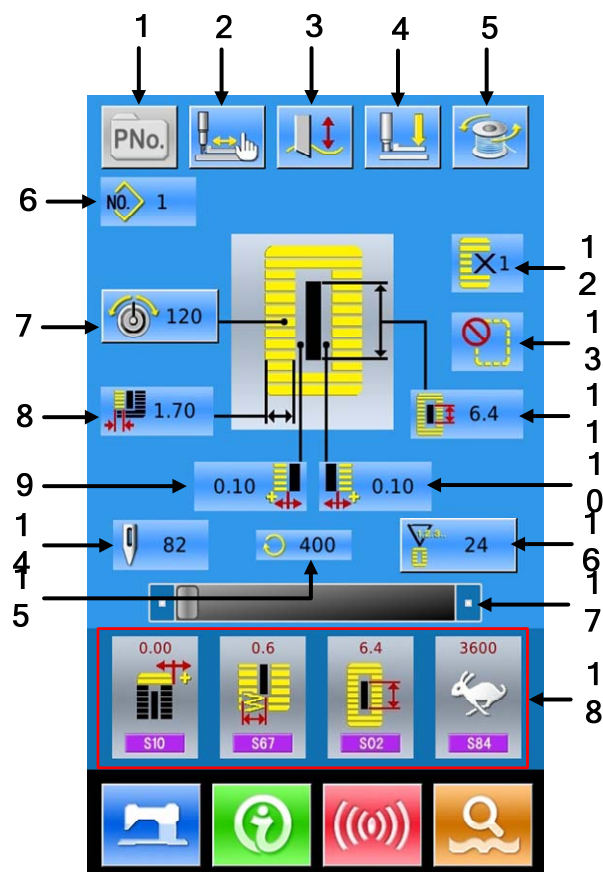



No.	Figure	Function	Remarks
5		Winding	
6		Pattern No. Selection	Pressing this button can enter the pattern selection interface
7		Set Upper-Thread Tension (S51, S52, S55, S56)	S52 and S56 will be influenced by the data switch of sewing.
8		Set/Return to Left Over-edging Width	For the pattern from No.1~ No.26, this button means to set left over-edging width; while for the patterns from No.27~ No.30, this button means to return to the Width Setting
9		Set Left Width of Knife Groove	Unavailable for Pattern No.27 &No.29
10		Set Right Width of Knife Groove	Unavailable for Pattern No.27 &No.28
11		Length of Cloth Cutting	
12		Set Double Stitching or Single Stitching	Unavailable for Pattern No.27, No.28&No.29
13		Set Numbers of Basting	Unavailable for Pattern No. 30
14		Set Sewing Data	
15		Select Type of Presser foot	
16		Customer Management	Set 4 buttons on the main interface for the 4 most frequently used sewing data groups
17		Directly Select Pattern by Number	
18		Sewing Pattern Selection	

(2) Interface of Sewing

Press  to enter the Sewing Interface shown as the figure at right. For detailed functions please take the Function Key List for reference.



Function Key List:

No.	Figure	Function	Remarks
1		P Pattern Selection Key	Controlled by Parameter k18
2		Trial sewing	
3		 : Knife Available  : Knife Unavailable	Shift Knife Status
4		Threading (Lower the presser)	
5		Winding	
6		Pattern No. Display	
7		Upper-thread Tension Setting	
8		Left Over-edging Width	

No.	Figure	Function	Remarks
9		Left Width of Knife Groove	
10		Right Width of Knife Groove	
11		Length of Cloth Cutting	
12		Single Stitching/ Double Stitching	
13		Numbers of Basting	
14		Total Number of Stitches	
15		Current Sewing Speed	
16		Counter Value : Sewing Counter : No. of piece counter	
17		Speed Setting	Controlled by Parameter k07
18		Customer Management	

4. 2 Pattern Registration

500 normal patterns can be registered for the most.

press to enter the interface of Pattern Registration (shown as the right figure):

① **Input Pattern No.**

Input the pattern No. via keyboard. If the pattern number is already existed in the system, the look and relevant information of the registered pattern will be shown on the upper interface. The used

number can't be reused, but by pressing ,

the unregistered number can be searched.

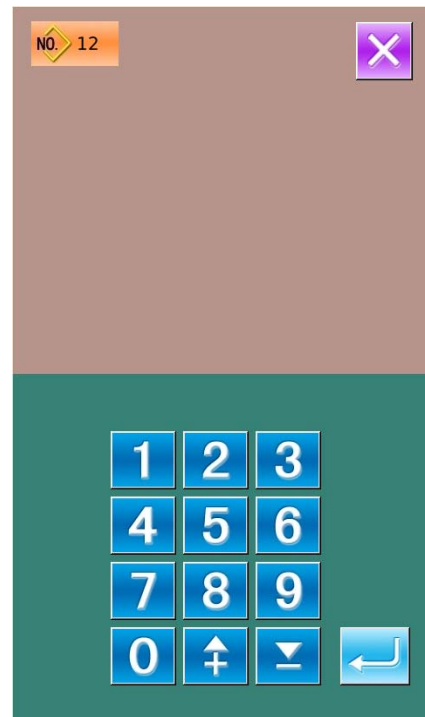

② **Select the 1st bar-tacking Sewing shape**

After setting the pattern number, user can press  to enter the interface for selecting the 1st bar-tacking sewing shape (as shown in right figure).

Press  to quit the selection.

Note: The Number of Sewing Shape is controlled by the parameter K04. Please refer to the Section 4.9 Sewing Shape Selection.



③ **Finish the Selection**

After user selects the 1st bar-tacking shape, the system will enter the interface of selecting the finish shape (as shown in the right figure).

Press  to finish the registration of new pattern and return to the main interface. According to the selected shape for sewing, user can set the initial value of sewing data

Press  to quit the selection

Note: The Number of Sewing Shape is controlled by the parameter K04. Please refer to the Section 4.9 Sewing Shape Selection.

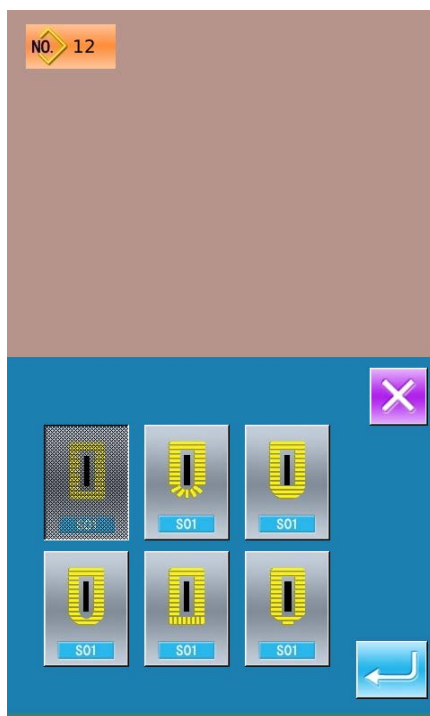

4.3 Pattern Copy

① Select the target pattern

Press  to enter the interface for copying the pattern (as shown in right figure).

A、Among the registered patterns, select the pattern number of the copied one and press . Then the system will enter the interface for inputting the registration number.

B、Press  to quit the pattern copy interface directly

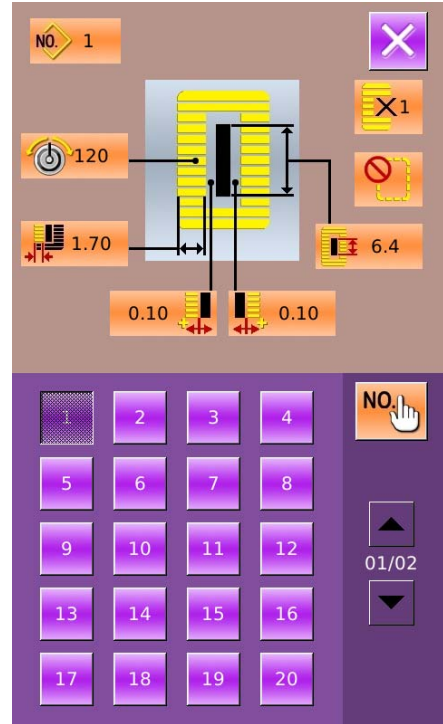

② Input the newly registered pattern number

In the interface, the upper area displays the shape and relevant sewing data of the copied pattern. The user can select the unregistered pattern number via the numeral keys. The registered pattern number can't be registered again.



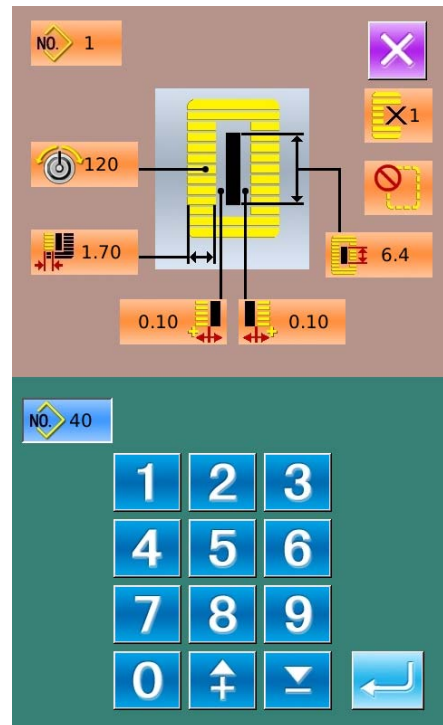

A、Press  to finish the operation of copying the pattern. And return to the pattern copy interface



B、Press  to quit the number input interface directly.



4. 4 Pattern Naming

Press  to enter the interface for naming pattern (as shown in the right figure), 12 figures can be inputted at the most.

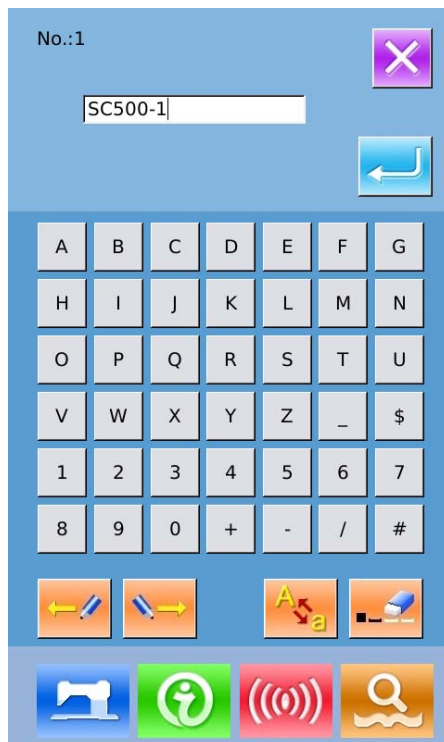

-  : Icon Right-moving
-  : Icon Left-moving
-  : Caps Locks
-  : Eraser

- A、 Select the figure wanted, press  to end the operation of naming the pattern.
- B、 The position of figure can be determined by moving the icon, the Eraser is used to delete the figure
- C、 Press  to quit directly.



4. 5 Threading

Press  to enter the interface of threading; at this moment, the presser foot is lowering. Pressing the Presser Foot Up will lift the presser and have the screen to return to the main interface.

-  : Presser Down
-  : Presser Up

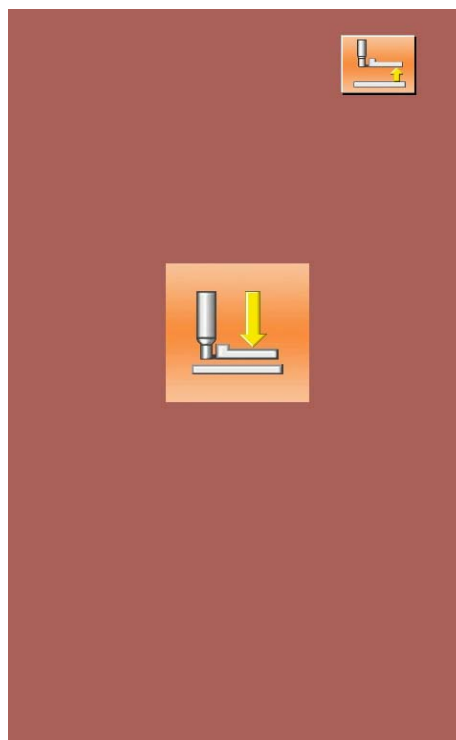

4.6 Winding

① Install the shuttle core

Fit the shuttle core fully onto the winder shaft. Then push the thread guide in the direction of the arrow (as shown in the figure in right)

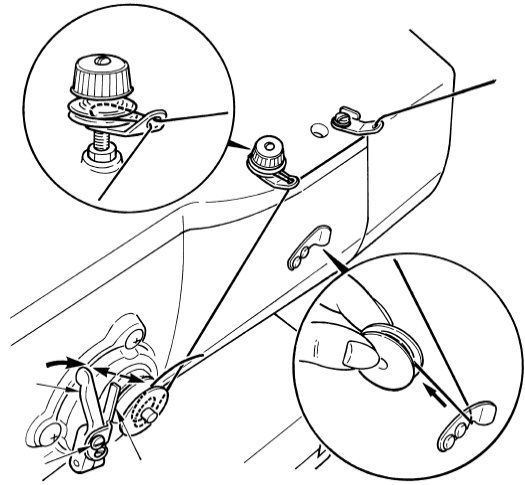

② Display the bobbin thread winding screen

Press  in the data input interface (orange) or the sewing interface (blue), and then the winding interface will be displayed (as shown in the right figure)

③ Start Winding

Step the start pedal, and then the sewing machine runs and starts winding bobbin thread.

④ Stop the sewing machine

Press STOP button  to stop the sewing machine. The system will return to the normal mode. By the way, in the bottom-thread winding mode, stepping the start pedal will stop the machine at this mode. Step the pedal again to resume winding. This function can be used at winding several shuttle cores.

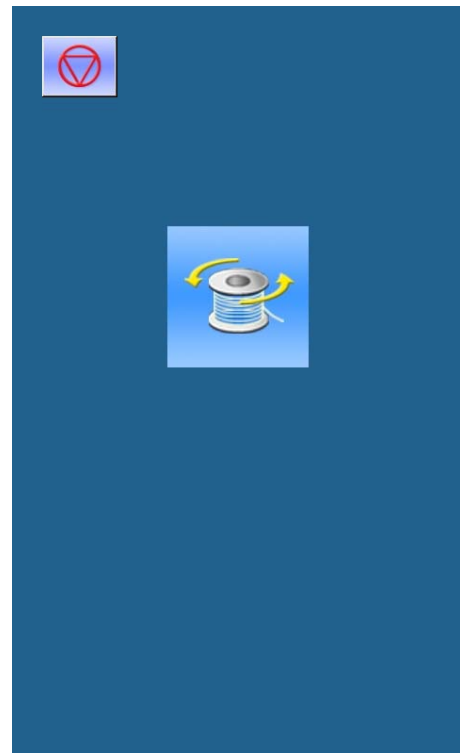

4. 7 Select the Type of Presser

① Display the data input Interface

Only at the data input interface (orange), can user change the contents of setting. In the sewing interface (blue), press READY key to display the data input interface.

② Call the interface for selecting presser type

Press Presser Type Selection (A) to display the interface for selecting the presser type (as shown at right).

③ Select the type of presser

Press button of presser type according to the presser mounted on the sewing machine. The button pressed is displayed in shadow. For selecting the presser type, please refer to the table below

	Type	Presser Type
	Type 1	
	Type 2	
	Type 3	
	Type 5	—

※ Set type 5 when using the presser foot other than type 1 to 3. Change memory switch (level 1) according to U15 Presser size width and U16 Presser size length. When using type 5 with stitch width at 6 mm or more and length at 41 mm or more, it is necessary to replace components such as presser arm, feed plate, etc

④ Determine the presser type

Press to close the interface and finish the

change. Pressing is to quit directly

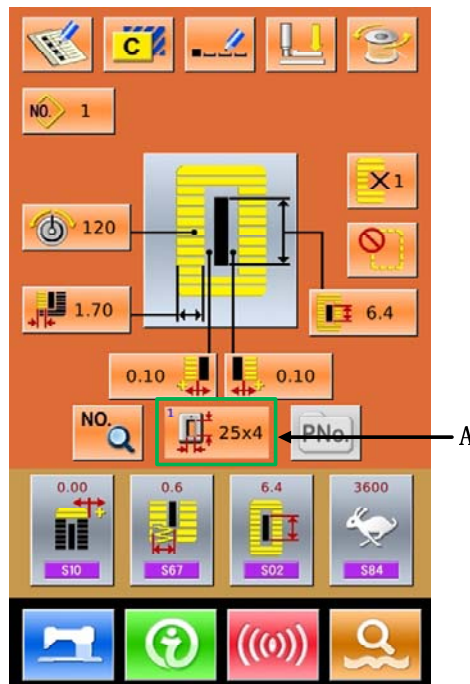

4.8 Pattern Selection

Press  to enter the interface for selecting pattern (as shown in the right figure), the upper area shows the shape and relevant data of the selected pattern while the lower area shows the registered number of the pattern.

: Input the number to inquire pattern

: Delete the pattern

① Pattern Selection

Every 20 numbers will be showed in one page, if exceeding, the page-turning key will be displayed and available in the interface. When the number of the registered pattern is selected, the upper area of the interface will show the details of the pattern.

Press  to finish the operation of pattern selection.

Press  to quit the Pattern Selection.

② Pattern Inquiry

Press  to activate the interface of Pattern Inquiry, input the number of pattern via the number keys, as shown in Figure 2

③ Pattern Deletion

Select the registered pattern and then press , the pattern will be deleted. However, the patterns in following three kinds can't be deleted

- A: Patterns included in continuous sewing
- B: Patterns included in cyclic sewing
- C: Patterns registered to P pattern

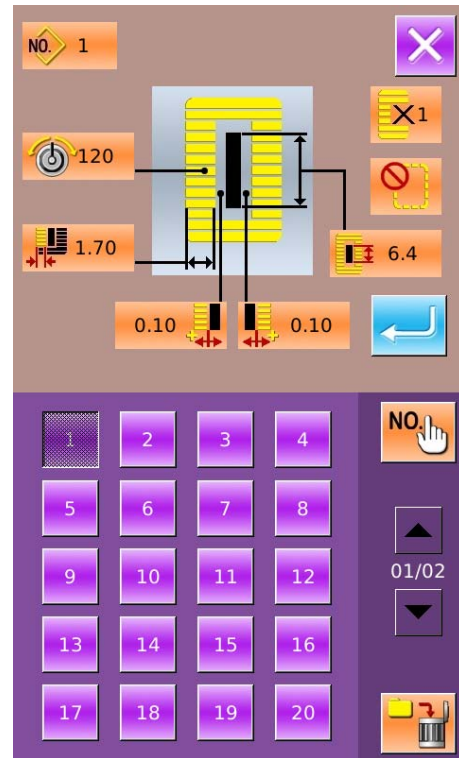

Figure 1

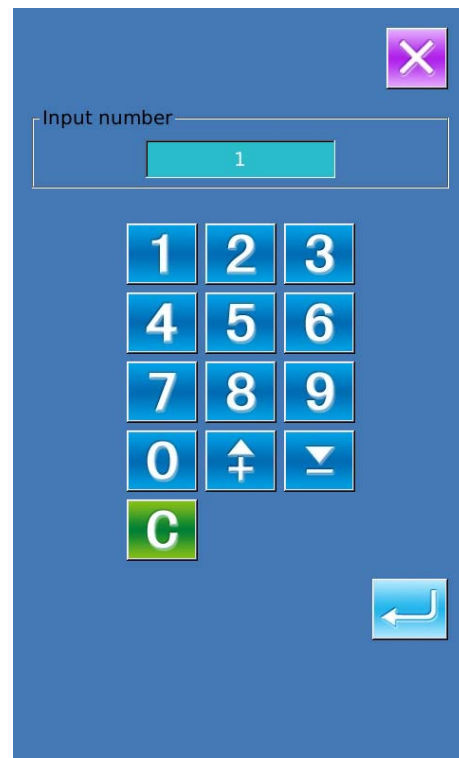



Figure 2

4. 9 Sewing Shape Selection



Press  to enter the interface for selecting the sewing shape

① Select the 1st bar-tacking

There are five common 1st bar-tacking shapes, which are Square Type, Radial Type, Eyelet Type, Semi-lunar Type and the Round Type. When the parameter K04 is set to 30, another 4 types of bar-tacking section can be used, which are bar-tacking section sewing, bar-tacking with left cut, bar-tacking with right cut and bar-tacking with center cut. Select the 1st bar-tacking section to enter the interface for selecting the shape. For the pattern from No.27 ~No.30, the user can press



to end the selection



Press to quit directly.

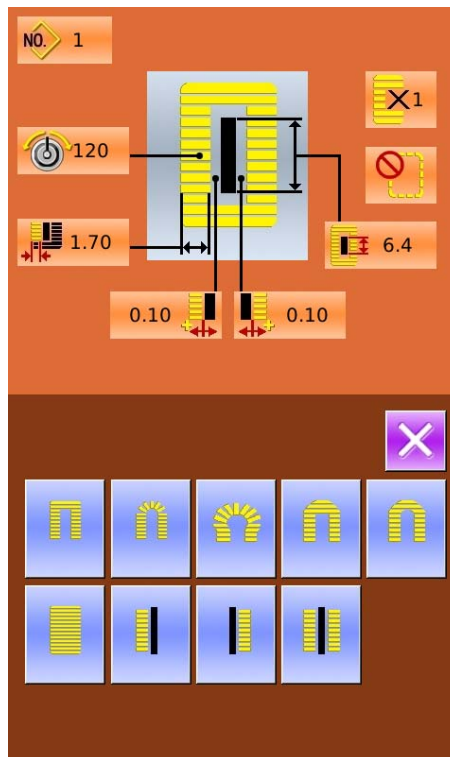

- Note:**
1. The display of 1st bar-tacking section is affected by parameter K04;
 2. When changing the 1st bar-tacking section, user has to change the sewing parameters of the relating shape. Otherwise, it may affect the data at pattern-designing or the sewing effect;
 3. For the default parameter value of the shape, please refer to 10.4 “Sewing Default Value List” in Appendix 1

② Finish the sewing shape selection

Select the end shape; press  to return to the main interface.

Press  to quit directly. The shape number will not be changed either

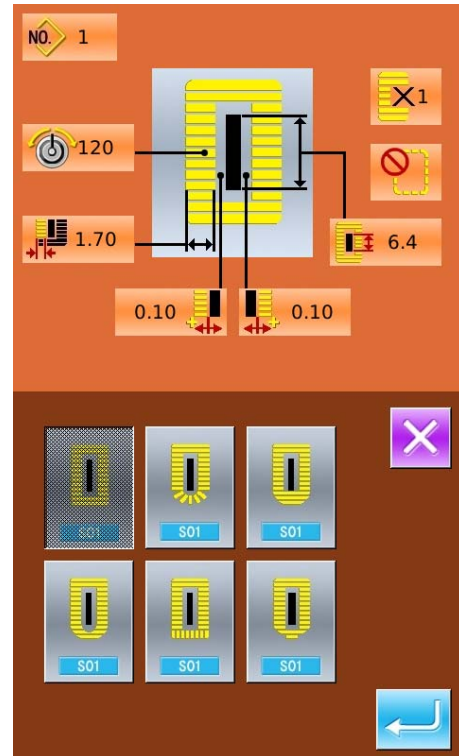











③ Parameter K04





















	K04 = 12	K04 = 20	K04 = 30
Square	1	1, 18, 19, 20	1, 18, 19, 20, 21, 22
Radial	3, 4, 5, 6	3, 4, 5, 6	3, 4, 23, 24, 5, 6
Eyelet	7, 8, 9, 10	7, 8, 16, 17, 9, 10	7, 8, 16, 17, 9, 10
Semi-lunar	11	13, 11, 14, 15	13, 25, 11, 26, 14, 15
Round	12, 2	12, 2	12, 2
Bar-tacking			27, 28, 29, 30

Note 1: The numbers in form are the number of shape.

Note 2: The sewing shapes of No.27, 28, 29 and 30 can only be available when parameter K04 is set at 30.

④ Sewing Shape List

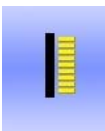
01 Square 	02 Round 	03 Radial Square 	04 Radial 	05 Radial Straight Bar-tacking 
06 Radial Taper Bar-tacking 	07 Eyelet Square 	08 Eyelet Radial 	09 Eyelet Straight Bar-tacking 	10 Eyelet Taper Bar-tacking 

11 Semi-lunar 	12 Round Square 	13 Semi-lunar Square 	14 Semi-lunar Straight Bar-tacking 	15 Semi-lunar Taper Bar-tacking 
16 Eyelet Semi-lunar 	17 Eyelet Round 	18 Square Radial 	19 Square Semi-lunar 	20 Square Round 
21 Square Straight Bar-tacking 	22 Square Taper Bar-tacking 	23 Radial Semi-lunar 	24 Radial Round 	25 Semi-lunar Radial 
26 Semi-lunar Round 	27 Bar-tacking 	28 Bar-tacking Right Cut 	29 Bar-tacking Left Cut 	30 Bar-tacking Center Cut 

4. 10 Sewing Data Setting

① Change Sewing Data

Press  to enter the interface for setting sewing (as shown in right figure).
 Select the sewing data for changing; Then the system will enter the setting status. The parameters with **purple** background are the input type, while the parameters with **blue** background are the selection type

Press  to quit the Sewing Data Setting.

Example at below:

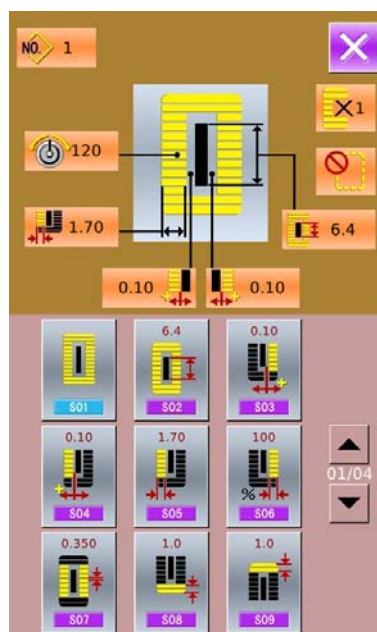

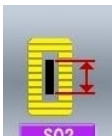
Select  to enter the interface (as shown in right).



Select  to enter the interface(as shown in right).

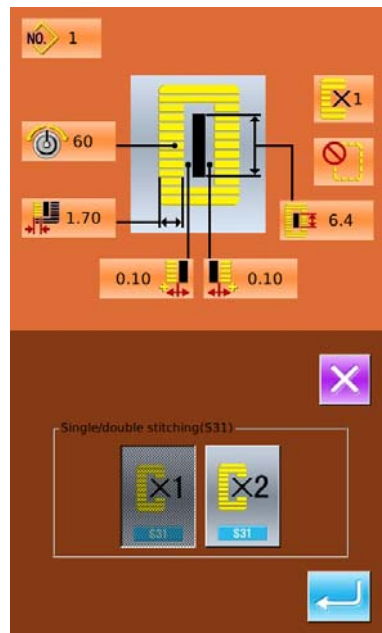

② Sewing Data List

The sewing data is related to the sewing shape selected. The different shape has the different sewing data with different default values

In mode status, user can set whether to open some sewing data. By the way, there are also some sewing data that are affected by others.

No.	Item	Range	Unit	Remarks
S01 	Sewing shape Refer to 4.9 Selection of Sewing Shape	1~30	1	Remarks 5

No.	Item	Range	Unit	Remarks
S02 	Length of cloth cutting This item sets the length of cloth that is cut by knife. However, in case of the shapes of No. 27, 28, 29 and 30, sewing length will be set. When activating U19 parameter (knife action number), the machine will cut the fabric according to the value in U18 (knife size).	3.0~120.0	0.1mm	
S03 	Knife groove width, right This item sets the clearance between knife and right parallel section.	-2.00~2.00	0.05mm	
S04 	Knife groove width, left This item sets the clearance between knife and left parallel section.	-2.00~2.00	0.05mm	
S05 	Over-edges width, left This item sets the over-edges width of left parallel section.	0.10~5.00	0.05mm	
S06 	Ratio of right and left shapes This item sets scale ratio of right side shape with the knife position as the center	50~150	1%	
S07 	Pitch at parallel section This item sets sewing pitch between left and right parallel sections.	0.200~2.500	0.025mm	
S08 	2nd bar-tacking length This item sets length of bar-tacking on the front side Square Down  Bar-tacking Down  Taper Down 	0.2~5.0	0.1mm	
S09 	1st bar-tacking length This item sets length of bar-tacking on the rear side Square Up 	0.2~5.0	0.1mm	
S10 	Compensation of bar-tacking width, right This item adjusts right over-edges section. of bar-tacking part Both 1st and 2nd bar-tacking can be adjusted Square Up  Square Down  Bar-tacking Down 	-1.00~1.00	0.05mm	
S11 	Compensation of bar-tacking width, left This item adjusts left over-edges section of bar-tacking part	-1.00~1.00	0.05mm	

No.	Item	Range	Unit	Remarks
S12 	Left Taper Bar-tacking This item sets length of bar-tacking section in taper bar-tacking shape	0.00~3.00	0.05mm	Remarks 1
S13 	Right Taper Bar-tacking This item sets length of bar-tacking section in taper bar-tacking shape	0.00~3.00	0.05mm	Remarks 1
S14 	Eyelet shape length This item sets upper side length from center of eyelet in the eyelet shape	1.0~10.0	0.1mm	Remarks 1
S15 	Number of stitches of eyelet shape This item sets number of stitches in the upper 90 ° of eyelet shape	1~8	1	Remarks 1
S16 	Eyelet width This item sets the inside crosswise size of the eyelet shape. Actual needle entry point is the dimension to which S04 Knife groove width, left is added.	1.0~10.0	0.1mm	Remarks 1
S17 	Eyelet length This item sets lengthwise size of the inside of eyelet shape.	1.0~10.0	0.1mm	Remarks 1
S18 	Round type shape length This item sets upper side length from the center of round shape Round Up  Radial Up  Semi-lunar Up  Round Down  Radial Down  Semi-lunar Down 	1.0~5.0	0.1mm	Remarks 1
S19 	Number of radial shape stitches This item sets number of stitches in the upper 90 ° of radial shape	1~8	1	Remarks 1
S20	Radial bar-tacking: This item sets with / without bar-tacking stitches of radial shape  : No  : Yes			Remarks 1 Remarks 2
S21 	Pitch at bar-tacking section This item sets the pitch of bar-tacking section. Square Up  Round Up  Semi-lunar Up  Square Down  Round Down  Semi-lunar Down  Straight Bar-tacking Down  Taper Down 	0.200~2.500	0.025	

No.	Item	Range	Unit	Remarks
S22 	1 st Clearance This item sets the clearance between 1st bar-tacking and knife groove. This item is applied to all shapes	0.0~4.0	0.1mm	
S23 	2 nd Clearance This item sets the clearance between 2nd bar-tacking and knife groove. This item is applied to all shapes	0.0~4.0	0.1mm	
S31	Single/ Double Sewing  $\times 1$: Single Sewing  $\times 2$: Double Sewing			
S32	Select Cross at Double Sewing At setting the double sewing, user can select parallel sewing and crossing sewing  $\times 32$: Parallel Sewing  $\times 32$: Cross Sewing			Remark 3
S33 	Compensation of Double Sewing Width This item sets amount to narrow over-edging width of 1st cycle at double stitching.	0.0~2.0	0.1mm	Remark 3
S34	Number of Basting Times This item sets number of basting times.  $\times 34$: Without basting  $\times n$: 1~9	0~9	1 Time	
S35 	Basting Pitch This item sets pitch at performing the basting.	1.0~5.0	0.1mm	Remark 3
S36 	Rolling Length of Basting This item sets rolling length of needle thread at performing basting.	2.0~20.0	0.1mm	Remark 3
S37 	Rolling Pitch of Basting This item sets rolling pitch of needle thread at performing basting.	0.2~5.0	0.1mm	Remark 3
S38 	Rolling Width of Basting This item sets rolling width of needle thread at performing basting.	0.0~4.0	0.1mm	Remark 3
S39 	Lengthwise Compensation of Needle Entry at Basting This item sets the amount to move needle entry position back and forth at performing basting more than two cycles	0.0~2.5	0.1mm	Remark 2 Remark 3
S40 	Horizontal Compensation of Needle Entry at Basting This item sets the amount to move needle entry position left and right at performing basting more than two cycles.	0.0~1.0	0.1mm	Remark 3

No.	Item	Range	Unit	Remarks
S41	 <p>Compensation of Left Side Position at Basting This item sets the adjustment amount of the standard sewing position at basting from the center of left over-edging.</p>	-2.0~2.0	0.1mm	Remarks 2 Remarks 3
S42	 <p>Compensation of Right Side Position at Basting This item sets the adjustment amount of the standard sewing position at basting from the center of right over-edging.</p>	-2.0~2.0	0.1mm	Remarks 2 Remarks 3
S44	 <p>Basting Speed Set Speed of Basing</p>	400~4200	100rpm	Remarks 3 Remarks 4
S45	 : Activate  : Deactivate <p>Pair-sewing: Select the Start of Sewing. After selecting “Activate”, user can perform the sewing in the order of “Pair Sewing ->Basting-> Normal Sewing”.</p>			
S46	 <p>Pair-sewing Width Set the width at pair-sewing.</p>	1.0~10.0	0.1mm	Remarks 2 Remarks 3
S47	 <p>Pair-sewing Pitch Set the pitch at pair-sewing.</p>	0.2~5.0	0.1mm	Remarks 2 Remarks 3
S51	 <p>Left Parallel Tension Set the needle thread tension at left parallel part.</p>	0~200	1	
S52	 <p>Right Parallel Tension Set the needle thread tension at right parallel part.</p>	0~200	1	Remark 2
S53	 <p>Left Parallel Tension (1st lap at double sewing) At double sewing, set the needle thread tension at the 1st lap in the left parallel part</p>	0~200	1	Remarks 2 Remarks 3
S54	 <p>Right Parallel Tension (1st lap at double sewing) At doubling sewing, set the needle thread tension at the 1st lap in the right parallel part</p>	0~200	1	Remarks 2 Remarks 3
S55	 <p>1st Bar-tacking Tension Set the upper the read tension at the 1st bar-tacking part</p>	0~200	1	
S56	 <p>2nd Bar-tacking Tension Set the upper the read tension at the 2nd bar-tacking part</p>	0~200	1	Remark 2

No.	Item	Range	Unit	Remarks
S57 	Set Needle Thread Tension at Sewing Start Set the needle thread tension of bar-tacking at sewing start	0~200	1	
S58 	Set the Needle Thread Tension at Basting Set the needle thread at basting	0~200	1	Remark 3
S59 	ACT Timing Adjustment at 1st Bar-tacking Start This item adjusts the start timing of needle thread tension output at 1st bar-tacking section.	-5~5	1 Stitch	Remark 2
S60 	ACT Timing Adjustment at Right Over-edging Start This item adjusts the start timing of needle thread tension output at right over-edging.	-5~5	1 Stitch	Remark 2
S61 	ACT Timing Adjustment at 2nd Bar-tacking Start This item adjusts the start timing of needle thread tension output at 2nd bar-tacking section.	-5~5	1 Stitch	Remark 2
S62 	Bar-tacking Stitch Number at Sewing Start Set the stitch number of bar-tacking sewing at sewing start	0~8	1 Stitch	
S63 	Bar-tacking Pitch at Sewing Start Set the stitch pitch of bar-tacking sewing at sewing start	0.00~0.70	0.05mm	Remark 2
S64 	Bar-tacking Width at Sewing Start Set the width of bar-tacking sewing at sewing start	0.0~3.0	0.1mm	
S65 	Vertical Adjustment of Bar-Tacking Sewing at Sewing Start Set the vertical start position of bar-tacking sewing at sewing start	0.0~5.0	0.1mm	Remark 2
S66 	Horizontal Adjustment of Bar-Tacking Sewing at Sewing Start Set the horizontal start position of bar-tacking sewing at sewing start	0.0~2.0	0.1mm	Remark 2
S67 	Bar-tacking Width at Sewing End Set the width of bar-tacking sewing at sewing end	0.1~1.5	0.1mm	
S68 	Bar-tacking Stitch Number at Sewing End Set the stitch number of bar-tacking sewing at sewing end	0~8	1 Stitch	
S69 	Vertical Adjustment of Bar-Tacking Sewing at Sewing End Set the vertical start position of bar-tacking sewing at sewing start	0.0~5.0	0.1mm	Remark 2
S70 	Horizontal Adjustment of Bar-Tacking Sewing at Sewing End Set the horizontal start position of bar-tacking sewing at sewing start	0.0~2.0	0.1mm	Remark 2

No.	Item	Range	Unit	Remarks
S81	Knife motion This item sets "With/without motion" of knife.  : Knife Off  : Knife On			
S83	Knife motion at 1st lap of double stitching This item sets "With/without motion" of cloth cutting knife at 1st lap at double stitching  : Knife Off  : Knife On			Remarks 2 Remarks 3
S84	 : Max Speed Limitation This item sets max speed of the sewing machine. The value is limited by the K07(Set maximum speed limitation)	400~4200	100rpm	Remarks 4
S86	 : Pitch of Forward This item sets sewing pitch at forward side of bar-tacking shape (Shape No. 27, 28, 29 and 30 of S01)	0.200~2.500	0.025	Remarks 1
S87	 : Width of Forward This item sets sewing width at forward side of bar-tacking shape (Shape No. 27, 28, 29 and 30 of S01)	0.10~3.00	0.05mm	Remarks 1
S88	 : Pitch of Return This item sets sewing pitch at return side of bar-tacking shape (Shape No. 27, 28, 29 and 30 of S01)	0.200~2.500	0.025mm	Remarks 1
S89	 : Width of Return This item sets sewing width at return side of bar-tacking shape (Shape No. 27, 28, 29 and 30 of S01)	0.10~3.00	0.05mm	Remarks 1

Remarks 1: Displayed according to the shape

Remarks 2: Displayed when it is set as activation

Remarks 3: Displayed when the function is selected

Remarks 4: It is limited by parameter K07

Remarks 5: When change the shape of 1st bar-tacking sewing, user needs to change the sewing parameters of the relating shape. Otherwise it will affect the generation of the pattern-designing data or the sewing effect

4.11 Direct Selection of Pattern

The user can register the 10 frequently used patterns to the direct keys for selecting directly, press  to enter the interface of selection as shown below.

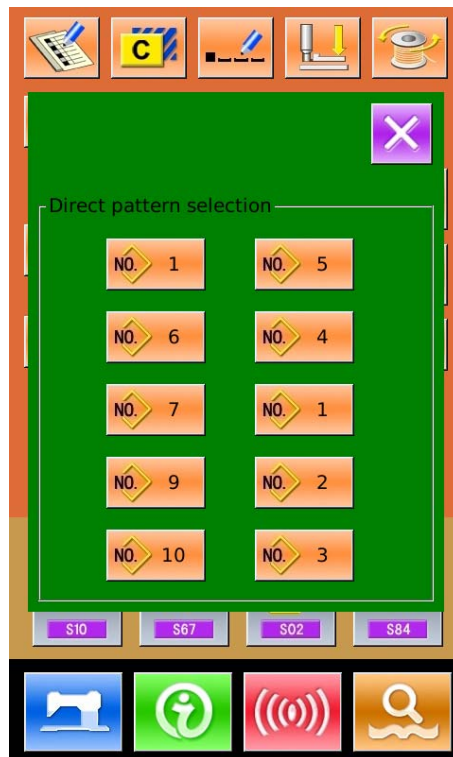

4.12 Trial Sewing





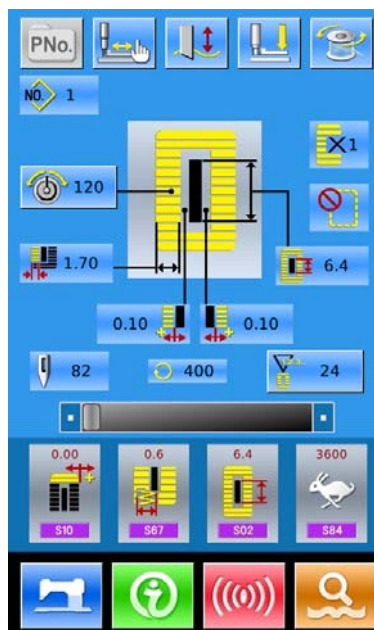





(1) Display the interface of sewing

At data input interface, press , the background of screen will change to blue, and the system enters the interface for sewing.





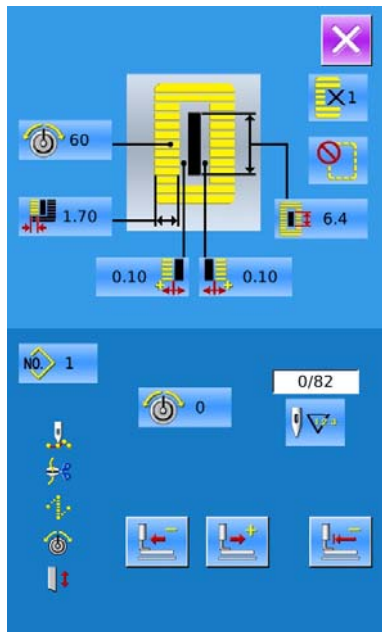

(2) Display of Trial Sewing

In the sewing interface. Press  to enter the trial sewing interface (As Shown at Right):

-  : Return to Origin
-  : Return
-  : Forward
-  : Tension at Stitch Point
-  : Current/ Total Stitch Number
-  : Sewing Order
-  : Thread Trimming Order
-  : Jump Feed Order
-  : Thread Tension Order
-  : Knife Driving Order



(3) Begin Trial Sewing

- A、By using ,  and  to start trial sewing (Single Step). Under this mode, step on the pedal switch to start the machine for sewing the leftover stitches.
- B、Holding  or  will have system to sew the entire pattern as trial.长
- C、During the trial sewing. The relating order marks at left side will be displayed in dark according to the sewing data

Exp: When the sewing data is the thread-trimming, the

figure will turn to .

(4) End Trial Sewing

Press  to quit the interface of trial sewing and return to the sewing interface.

4.13 Set Needle Thread Tension

At Changing the Thread Tension

① **Display the Data Input Interface**

Only on the data input screen (orange) or sewing screen (blue), needle thread tension can be changed. At the sewing screen (blue), press READY switch and display the data input screen (orange).

② **Call the interface for changing the needle thread tension**

Press  to display the interface for changing the needle thread tension (as shown in right figure).

③ **Change the Needle Thread Tension**

At the interface for changing the needle thread tension, user can change the needle thread tension at parallel part and bar-tacking part. By selecting



or user can set S51, S52, S55 or S56 respectively, among which the S52 and S56 can be deactivated at Edition of Sewing Data in Mode Status.

Press **【Tension 1】****【Tension 2】** to shift between two tension groups

④ **Finish the Change of Needle Thread Tension**

Press  to close the interface for changing Needle thread tension. And end the change.

※ **Change the tension other than that at parallel section and bar-tacking section**

Set value of tension at: 1.Parallel section; 2.Bar-tacking section



	Set value on panel			
		⊕	Initial value	⊖
Zigzag Buttonhole	①Parallel section tension	Crest is lowered	1 2 0	Crest is raised
	②Bar-tacking tension	Down Tension	3 5	Needle Thread Tension
Straight Buttonhole	①Parallel section tension	Down Tension	6 0	Needle Thread Tension
	②Bar-tacking tension	Down Tension	6 0	Needle Thread Tension

In case of the radial eyelet shape, set the bar-tacking tension to approximately 120 and make the balance of stitches

About Zigzag Buttonhole and Straight Buttonhole

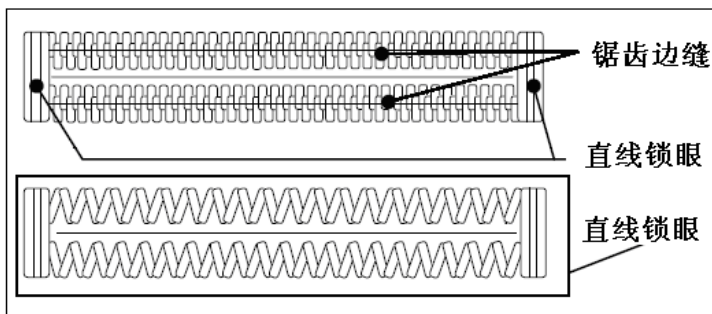

Zigzag Buttonhole



It enhances the needle thread tension. It is the zigzag stitch form that pass the center of the stitch form of needle thread at both sides

Straight Buttonhole
It is the retrieval stitch form, which only has needle thread on front surface of fabric, while bobbin thread at backside.

4. 14 Operation of Counter

(1) Set Counter



① Display the counter interface

In the sewing interface, press  (), the interface of counter setting comes out.

 : Sewing Counter

 : No. of Pieces Counter

The user can set the type of counter by choosing

 and , and set the value of counter

A、 Press  to activate the setting at return

B、 Press  to cancel the operation and return

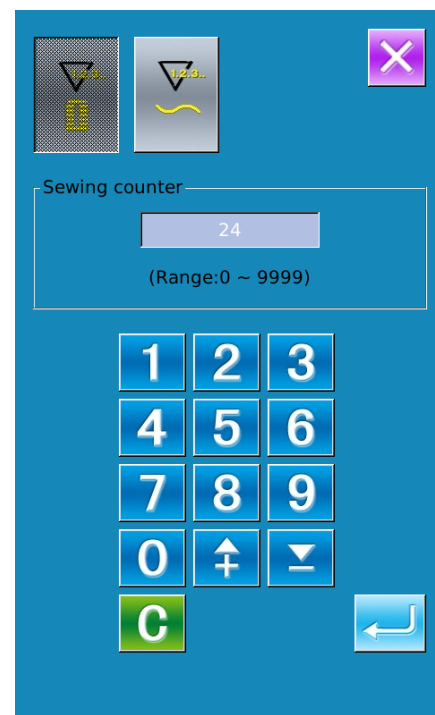

4. 15 Emergency Stop

When STOP switch is pressed during sewing, the sewing machine interrupts sewing and stops. The interface, as the figure at right, is displayed

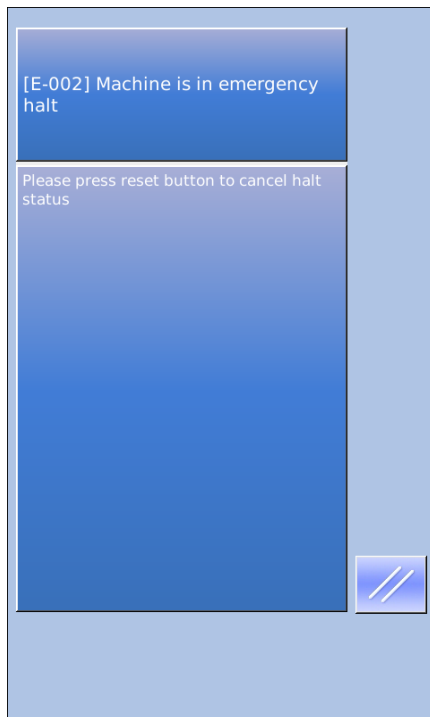

Press  to release the error. And the interface of single-step motion comes out (shown as the figure at right)

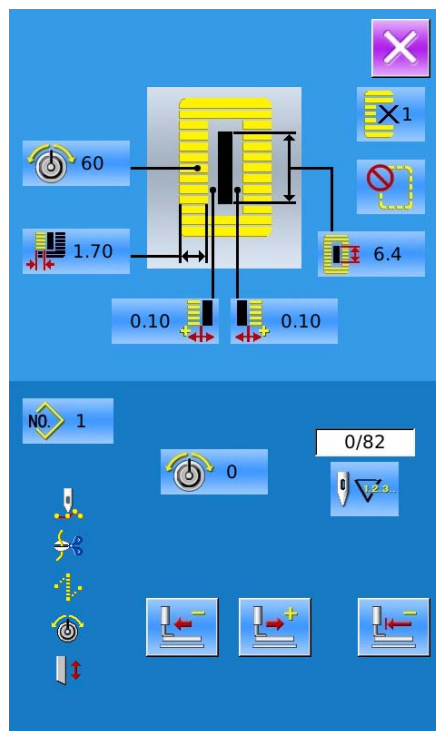



The operation is same as the operations in trial sewing. Step the pedal and continue the sewing.

4. 12 VDT Pattern Operation

4. 12. 1 Display and Operation of VDT Pattern

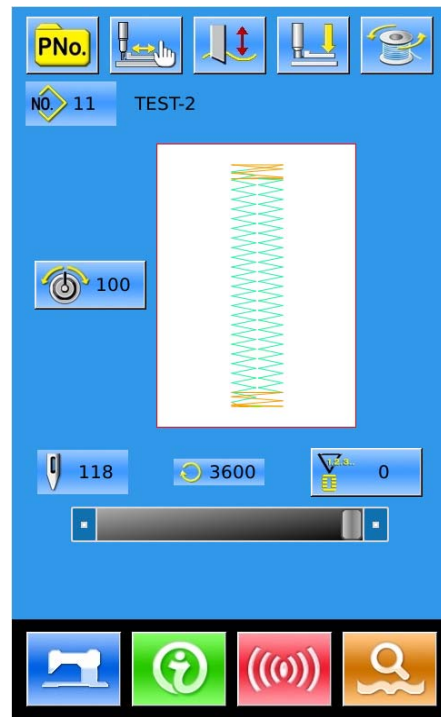
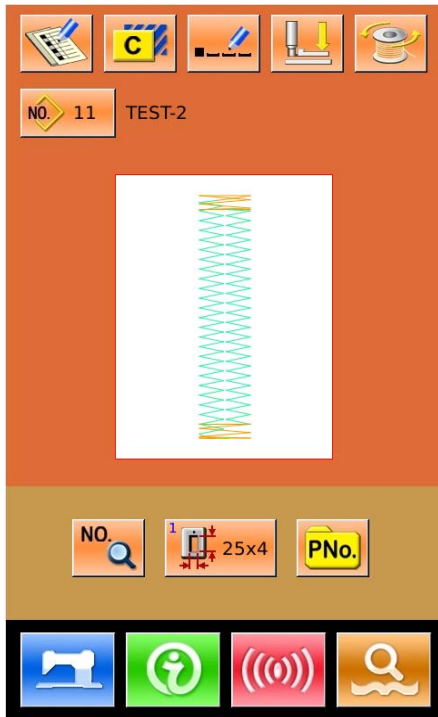
User can use the pattern-making software to create the patterns in VDT format. By inputting it from U disk to memory, the user can activate the data input interface and sewing interface as below:



Press  to enter the sewing data setting interface, as shown at right:

Press  to cancel the operation and return to main interface.

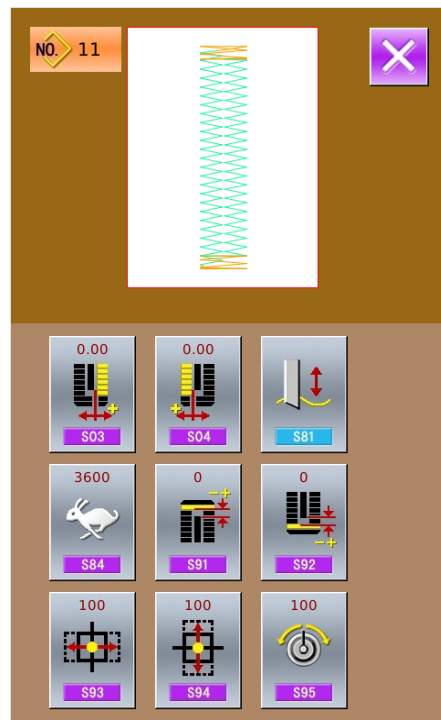

4. 12. 2 Sewing Data of VDT Pattern

Sewing Data List of VDT Pattern:

No.	Item	Range	Unit	Initial Value
 S03	Right Width of Knife Groove Set the interval between the knife and right parallel part.	-2.00~2.00	0.05mm	0
 S04	Left Width of Knife Groove Set the interval between the knife and left parallel part	-2.00~2.00	0.05mm	0
S81	Knife motion This item sets "With/without motion" of knife.  : Knife Off  : Knife On			Knife On
 S84	Max Speed Limitation This item sets max speed of the sewing machine. The value is limited by the K07(Set maximum speed limitation)	400~4200	100rpm	Parameter K07
 S91	1 st Pitch Adjustment	-9~9	1 针	0
 S92	2 nd Pitch Adjustment	-9~9	1 针	0
 S93	Scale Ratio (X Direction)	20~200	1%	100
 S94	Scale Ratio (Y Direction)	20~200	1%	100
 S95	Standard Tension	0~200	1	100

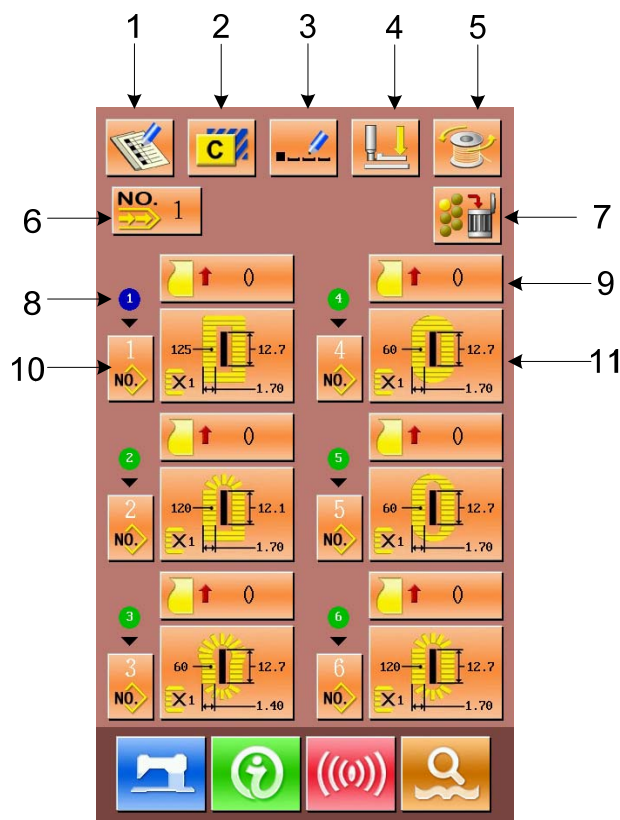

5 Continuous Sewing

This kind of sewing can sew 6 shapes at most without lifting presser. At most, 50 continuous sewing patterns can be registered.



5. 1 Function List

No	Figure	Function	Remarks
1		New Pattern Registration	
2		Pattern Copy	
3		Pattern Naming	
4		Threading	
5		Winding	
6		Select Pattern for Continuous Sewing	
7		Delete All	Delete the entire sub-pattern in the existing continuous pattern
8		Sewing Order	
9		Feeding Amount Input	

No	Figure	Function	Remarks
10		Sub-pattern Selection	
11		Sewing Data Edition	







5. 2 Edition of Continuous Sewing

5. 2. 1 Selection of Continuous Sewing Pattern

Press  to enter the interface for selecting the pattern

(as shown in right figure).

Please operate in the following way:

- A、 Press  &  to look up the information of the registered patterns in continuous stitching.
- B. Press  to select pattern via number
- C、 Press  to delete the selected pattern
- D、 Select the proper pattern, press  to end the selection and to return the main interface.
- E、 Press  to cancel the operation and return to main interface

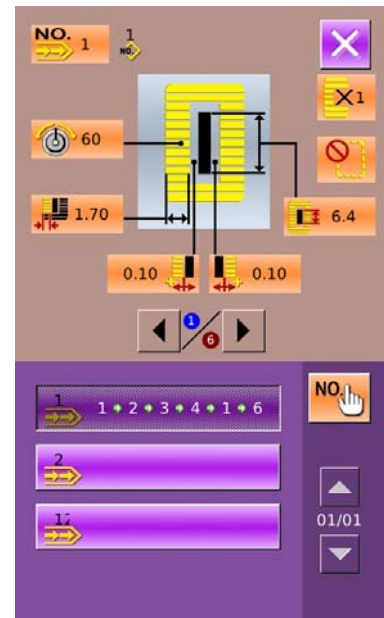

5. 2. 2 Edition of Continuous Sewing Pattern

① Set Cloth-feeding Amount

Press  (In figure 1) to enter the interface for setting the feeding amount (figure 2).

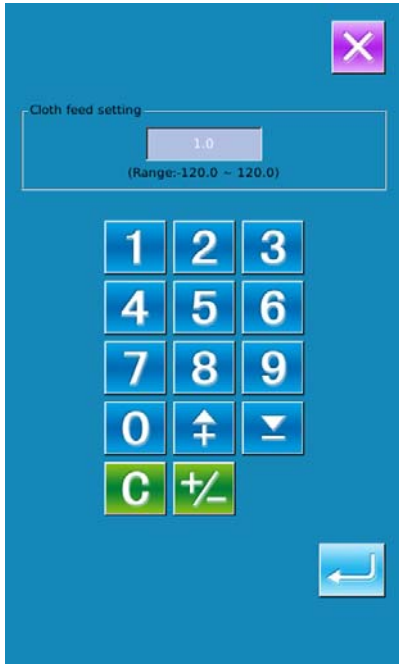

Figure 2

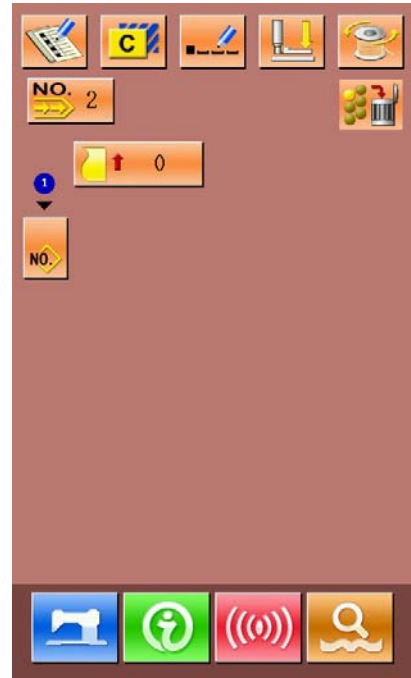





Figure 1

② Select Pattern

Press  to enter the interface for selecting pattern (as shown in right figure)

A、 In this interface, there are two ways to select pattern:

- Press  to input the pattern number
- Input pattern number directly

B、 Press  to delete the currently selected pattern

C、 Press  to cancel the operation

D、 Select the proper pattern and press  to confirm it.

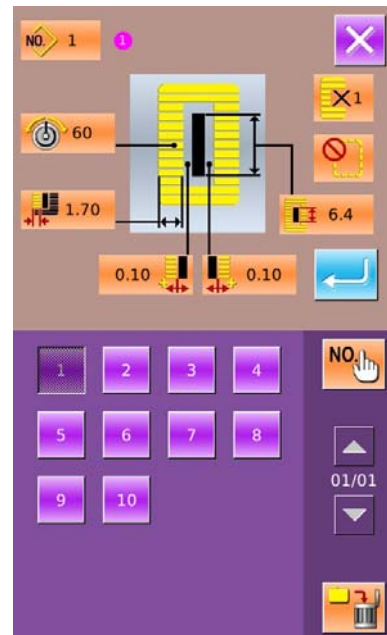

③ Change Sewing Data

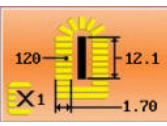
Press  to enter the interface for setting the sewing data (as shown in figure 2 at right).

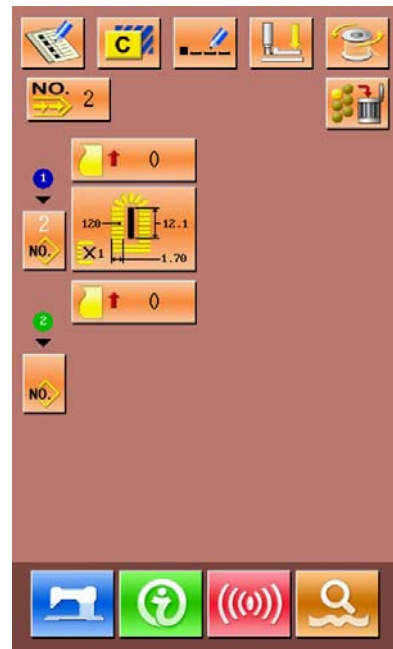

Figure 1

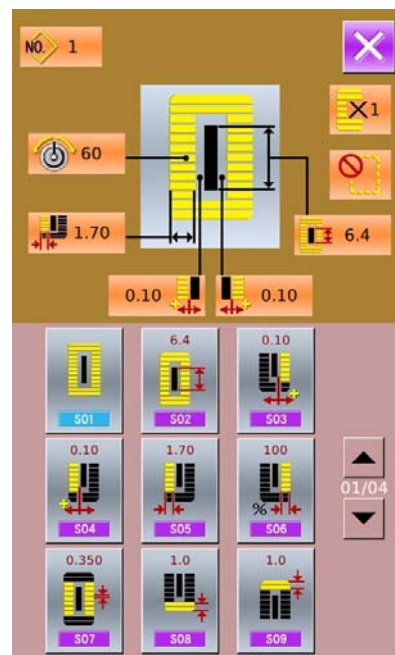





Figure 2

5. 2. 3 Continuous Sewing Pattern Registration

50 continuous patterns can be registered for the most. press  to enter the interface of Pattern Registration (shown as the right figure):

① **Input Pattern No.**

Input the number of the pattern via key board. The registered number can't be registered again. By pressing  and , user can search the unregistered number.

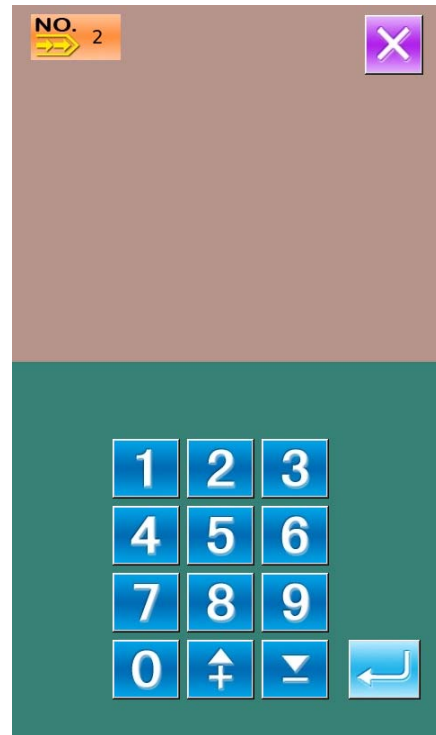

② **Edition of Continuous Sewing**

After setting the pattern number, please press  to enter the interface for editing the continuous sewing (as shown in right):
For the following operations, please refer to Section “5.2.2”

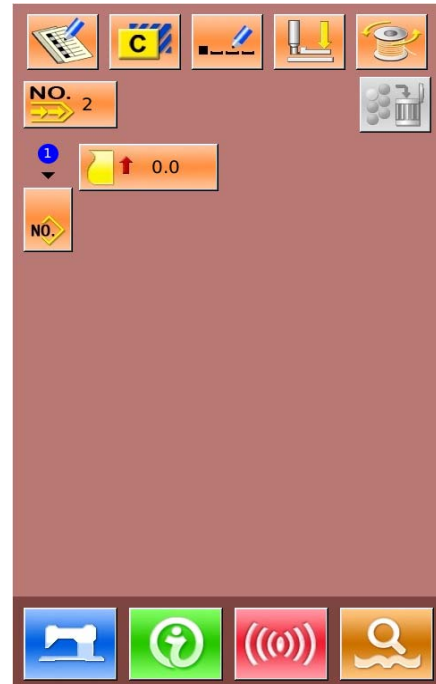



5. 2. 4 Continuous Sewing Pattern Copy

① Select the target pattern

Press  to enter the interface of pattern copy (as shown at right). Among the registered patterns, select the pattern number of the copied one and

press .

Press  and  to check the pattern shape contained in the continuous sewing

Press  to cancel the copy operation

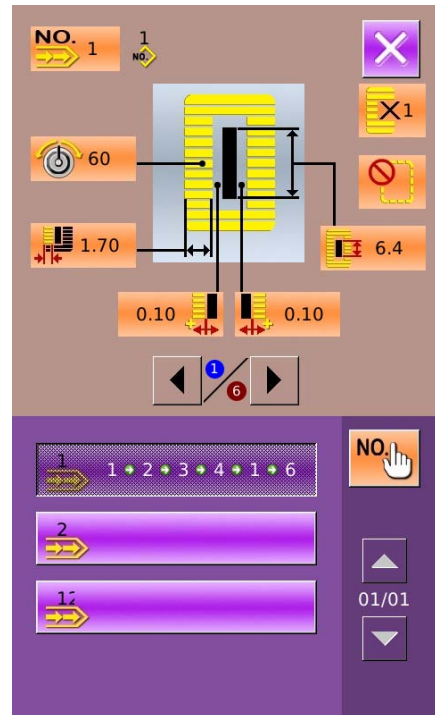

② Input the newly registered pattern number

In the interface, the upper area displays the shape and relevant sewing data of the copied pattern. The user can select the unregistered pattern number via the numeral keys.

Press  to finish the pattern copy operation

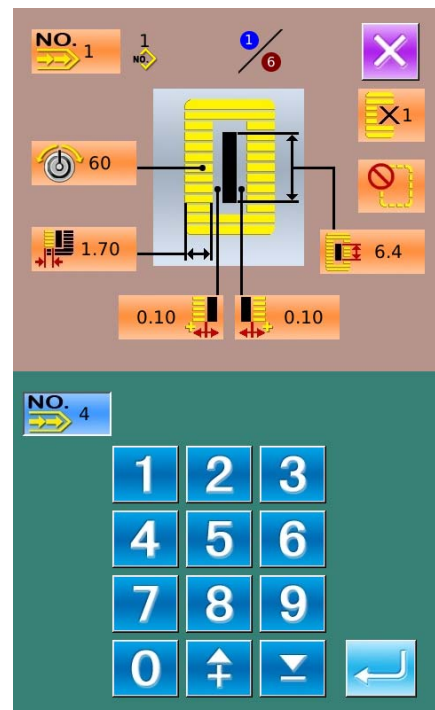

Press  to cancel the operation and return to the upper interface

※ The registered pattern number cannot be registered again.



5. 2. 5 Deletion of Continuous Sewing Pattern

① Select the target pattern

Press  to select pattern. Press  to return to the main interface, as shown at right.

Press  to delete the continuous sewing pattern

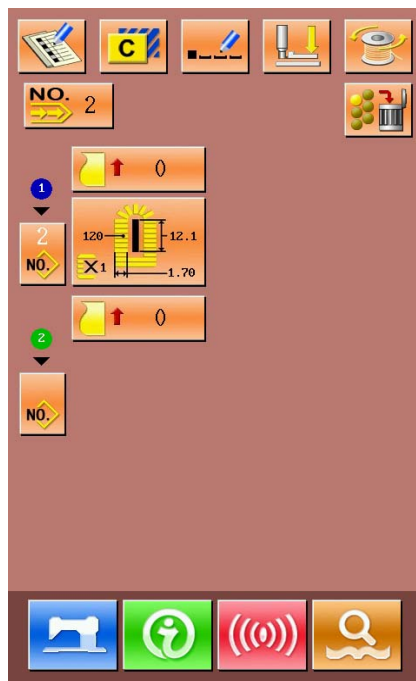

② Confirm the Deletion

Press  to finish the pattern deletion

Press  to cancel the operation

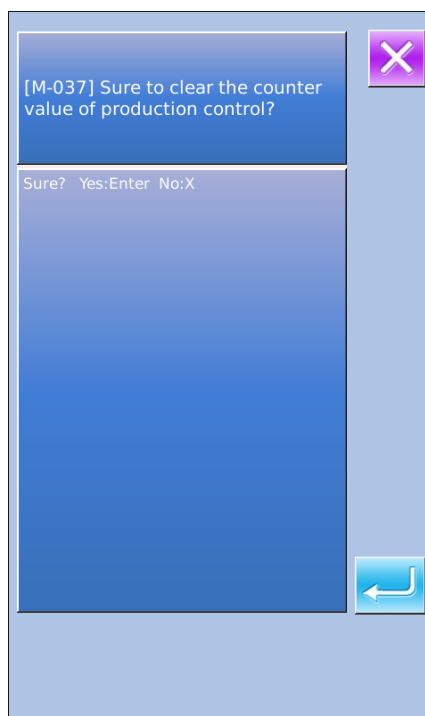

③ **Finish the Deletion**

After deleting the continuous sewing pattern, user can have system to return to main interface. Then user can edit the pattern again.

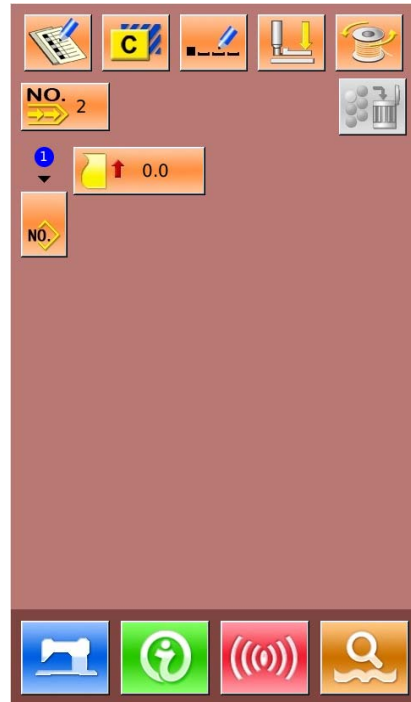

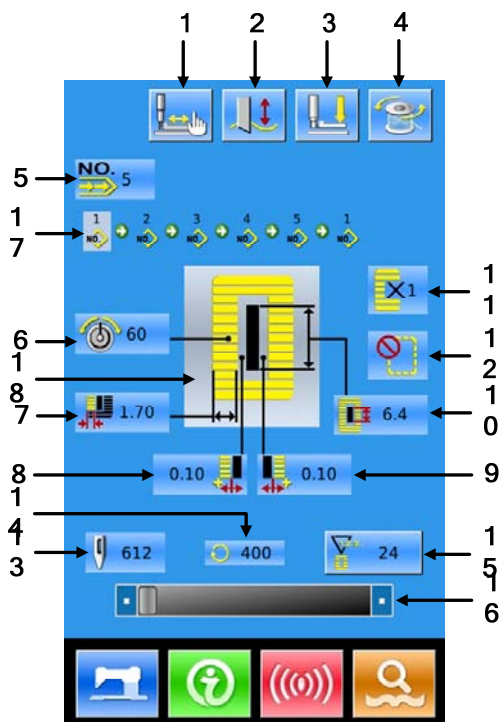

5. 3 Continuous Sewing Interface

Press  to enter the interface for sewing (as shown in right figure).



5. 3. 1 Function List

No.	Figures	Functions	Remarks
1		Trial Sewing	
2		Knife Function	Shift knife functions
3		Threading (Presser Down)	
4		Winding	
5		Pattern Number Display	
6		Needle Thread Tension Setting	
7		Left Over-edges Width	
8		Left Width of Knife Groove	
9		Right Width of Knife Groove	

No.	Figures	Functions	Remarks
10		Length of Cloth Cutting	
11		Single Sewing/ Double Sewing	
12		Number of Basting	
13		Stitch Number	
14		Current Sewing Speed	
15		Counter Value : Sewing Counter : No. of piece counter	
16		Speed Setting	
17		Pattern Number Input at Continuous Sewing Data	
18		Display of Sewing Shape	

5. 3. 2 Trial Sewing for Continuous Sewing





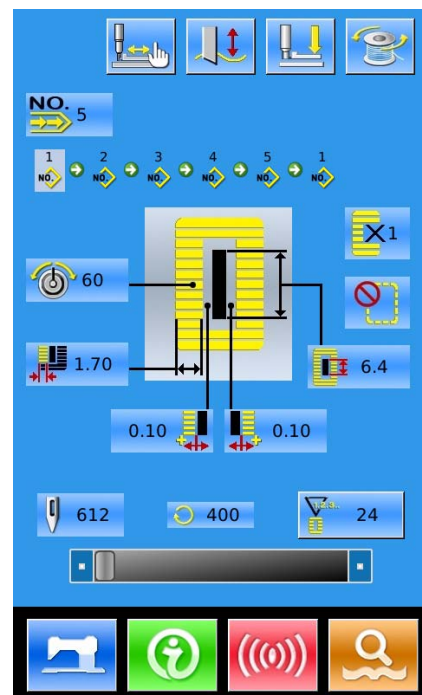





(1) Display the interface of sewing

At data input interface, press , the background of screen will change to blue, and the system enters the interface of sewing.





(2) Display of Trial Sewing

In the sewing interface. Press  to enter the trial sewing interface (As Shown at Right):

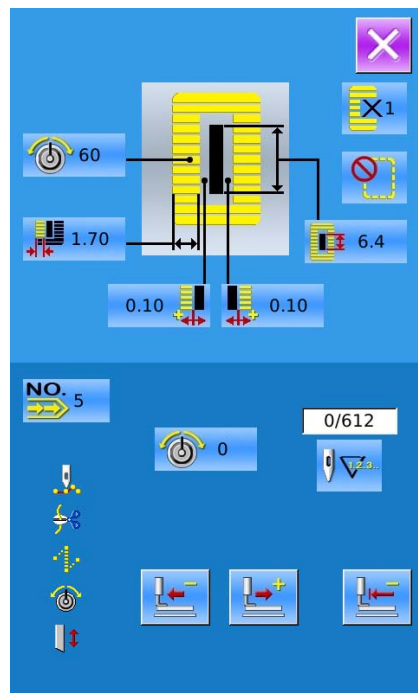
-  : Return to Origin
-  : Return
-  : Forward
-  : Tension at Stitch Point
-  : Current/ Total Stitch Number
-  : Sewing Order
-  : Thread Trimming Order
-  : Jump Feed Order
-  : Thread Tension Order
-  : Knife Driving Order



(3) Begin trial sewing

By using ,  and  to start trial sewing. Under this mode, step on the pedal switch to start the machine for sewing the leftover stitches

(4) End trial sewing





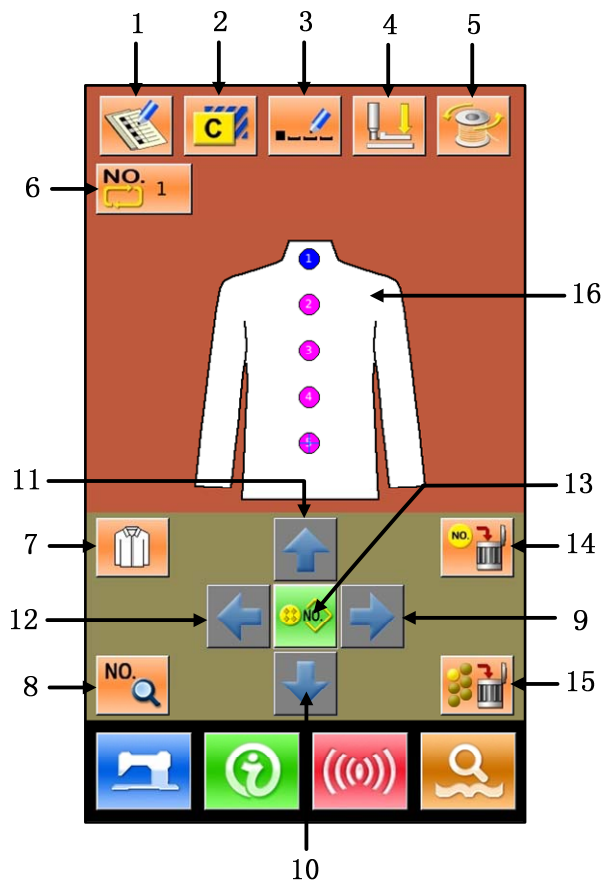

Press  to quit the interface of trial sewing and return to the sewing interface.







6 Cyclic Sewing

This function is used to sew several patterns in a cyclic order. User can input as many as 30 shapes within a cyclic sewing pattern. At most, 50 cyclic sewing patterns can be registered.



6. 1 Function List

No	Figure	Function	Remarks
1		New Pattern Registration	
2		Pattern Copy	
3		Pattern Naming	
4		Threading	
5		Winding	
6		Select Pattern for Cyclic Sewing	

No	Figure	Function	Remarks
7		Selection of Fabric	
8		Sewing Data Change	
9~12		Direction Key	
13		Pattern Selection	
14		Delete Sub-pattern	Delete the sub-pattern covered by icon
15		Delete All Sub-pattern	Enable to delete the entire sub-pattern within the current cyclic sewing
16		Sewing Order	

6. 2 Edition of Cyclic Sewing

6. 2. 1 Pattern Registration

Input the pattern number via number keyboard

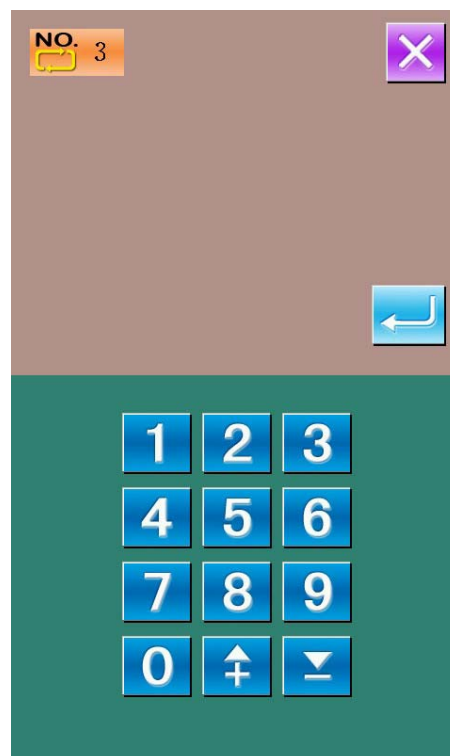

Press  to end selection

Press  to quit selection



6. 2. 2 Pattern Copy

① Select the target pattern

Press  to enter the interface of pattern copy (as shown at right). Among the registered patterns, select the pattern number of the copied one and press .

Press  to quit the copy operation.

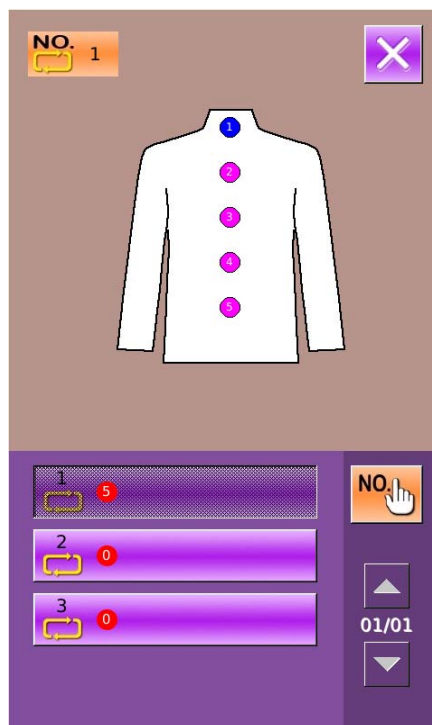

② Input the newly registered pattern number

In the interface, the upper area displays the shape and relevant sewing data of the copied pattern. The user can select the unregistered pattern number via the numeral keys. But the registered pattern number cannot be registered again.

Press  to finish the pattern copy operation

Press  to quit

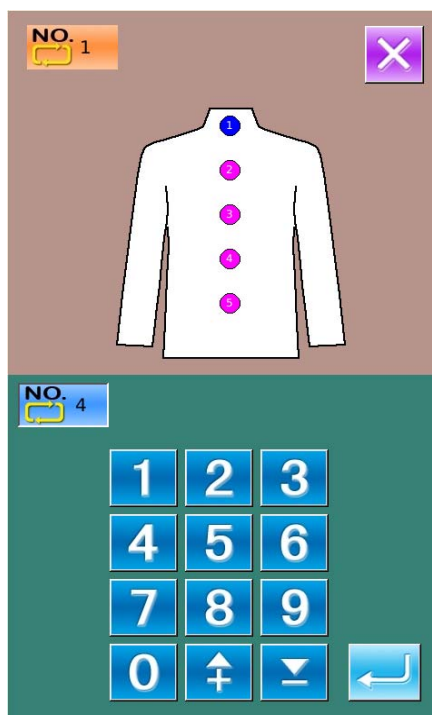

6. 2. 3 Selection of Cyclic Sewing Pattern

Press  to enter the interface for selecting the cyclic sewing pattern (as shown in right).

The operation is same to the operation of normal pattern selection.

Press  to quit the pattern selection



6. 2. 4 Edition of Cyclic Sewing Pattern

① Start Edition

Press the direction keys , ,  &  to

select the position wanted, press  to enter the interface of pattern selection (as shown in right figure).

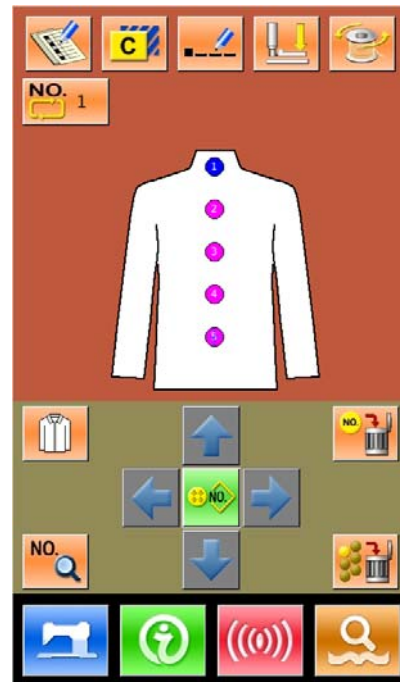



② Pattern Selection

: Input number to inquire patterns

: Delete the pattern

: Shift to selection of patterns for continuous sewing

Select the proper pattern and press  to end the selection.

Press  to quit directly.

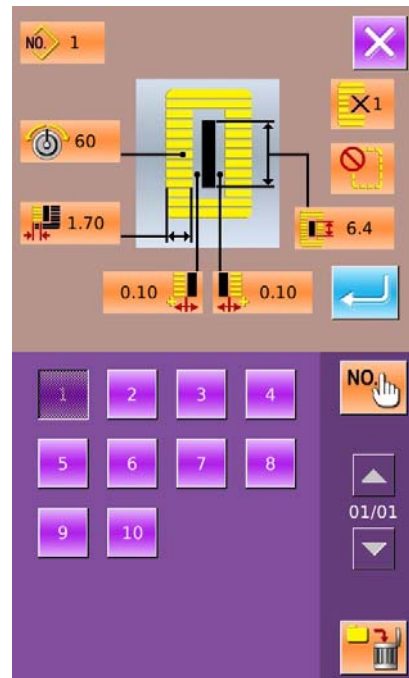

③ Change Sewing Data

Move the icon to the target position, press  to enter the interface for sewing data setting (as shown the figure below).

Press  to quit the relating sewing data change interface.

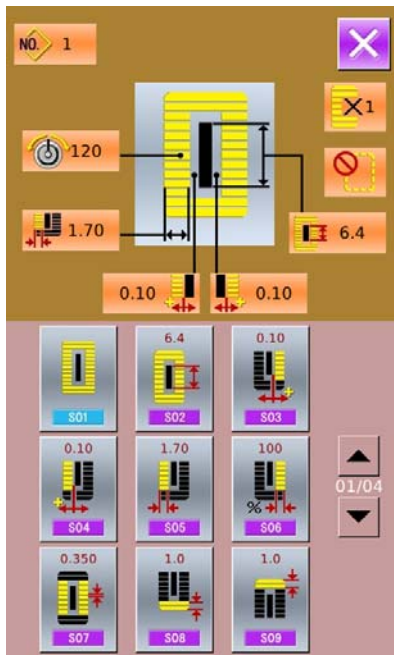

Left figure is the modification on sewing data of normal pattern. For specific operation, please take the section 4.10 Sewing Data Setting for reference.

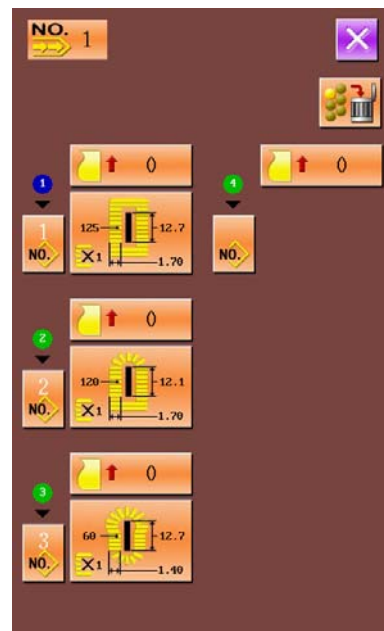

The right figure is the edition on the data of the continuous stitching. On specific operation, please refer to Continuous Sewing Data Input

6. 2. 5 Change Fabric

Press  to enter the interface for selecting the fabric (as shown in right figure).In this section, the user can modify the reference design in the interface of sewing data input.

Press  to quit; Press  to confirm the selection

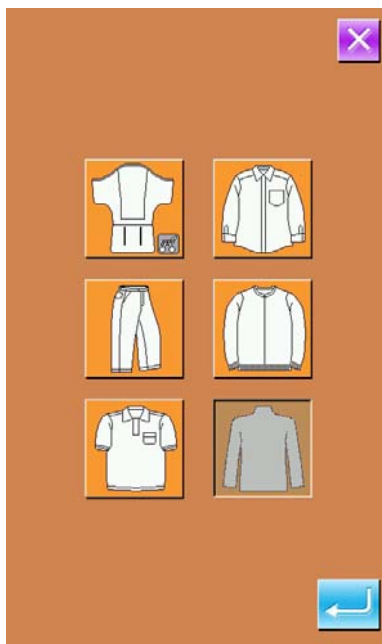





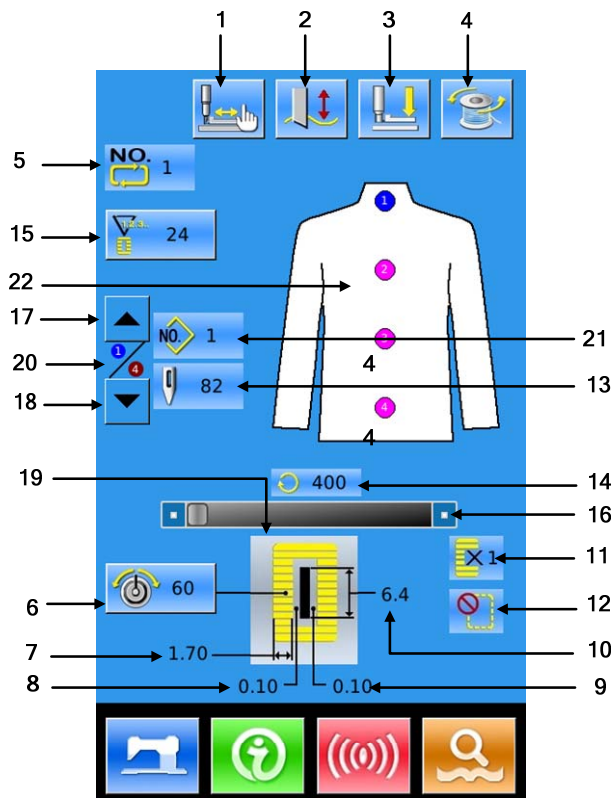





6. 3 Cyclic Sewing Interface

Press  to enter the sewing interface (as shown in right)



6. 3. 1 Function List

No.	Figures	Functions	Remarks
1		Trial Sewing	
2		Knife Function	Shift the knife activation
3		Threading (Presser Down)	
4		Winding	
5		Pattern Number Display	
6		Needle Thread Tension Setting	
7		Left Over-edging Width	
8		Left Width of Knife Groove	

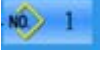
No.	Figures	Functions	Remarks
9		Right Width of Knife Groove	
10		Length of Cloth Cutting	
11		Single Sewing/ Double Sewing	
12		Number of Basting	
13		Stitch Number	
14		Current Sewing Speed	
15		Counter Value  : Sewing Counter  : No. of piece counter	
16		Speed Setting	
17		Sewing Order Reverse	Return to the previous sewing order
18		Sewing Order Forward	Go to next sewing order
19		Sewing Shape	
20		Sewing Order at Work	
21		Pattern Number at Current Sewing	
22		Sewing Order	

6.3.2 Trial Sewing at Cyclic Sewing





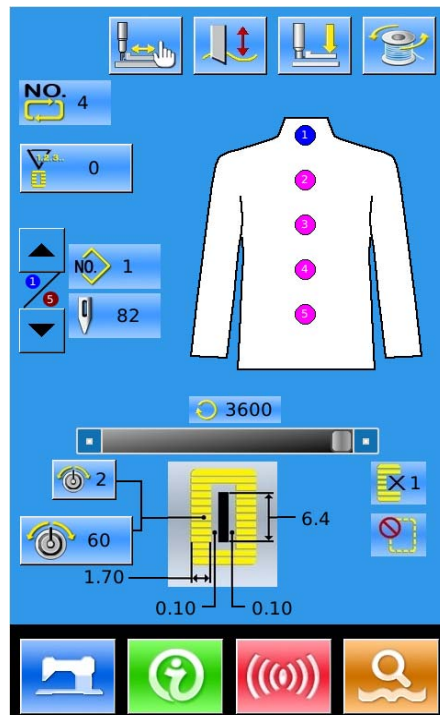





(1) Display Sewing Interface

At data input interface, press  , the background of screen will change to blue, and the system enters the interface of sewing.





(2) Display of Trial Sewing

In the sewing interface. Press  to enter the trial sewing interface (As Shown at Right):

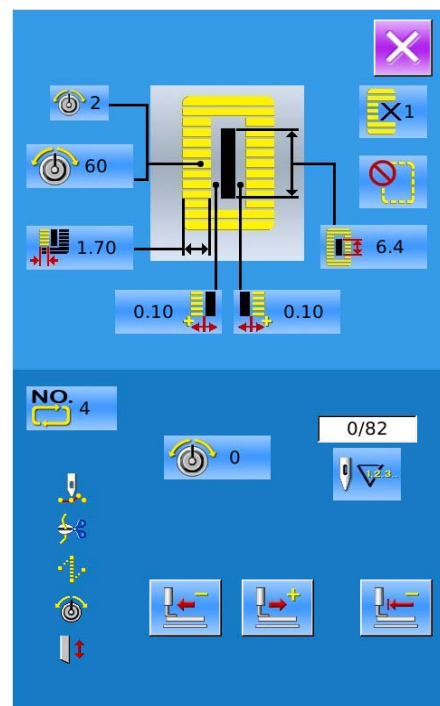
-  : Return to Origin
-  : Return
-  : Forward
-  : Tension at Stitch Point
-  : Current/ Total Stitch Number
-  : Sewing Order
-  : Thread Trimming Order
-  : Jump Feed Order
-  : Thread Tension Order
-  : Knife Driving Order



(3) Start Trial Sewing

By using ,  and  to start trial sewing. Under this mode, step on the pedal switch to start the machine for sewing the leftover stitches

(4) End Trial Sewing

Press  to return to the sewing interface from trial sewing interface

7 Mode Setting

Press  to shift between the Data Input Interface and Mode Interface (as shown in the right figure), and the detailed edition and setting can be carried out under this interface.

Note: For some button, user has to hold  to open them.

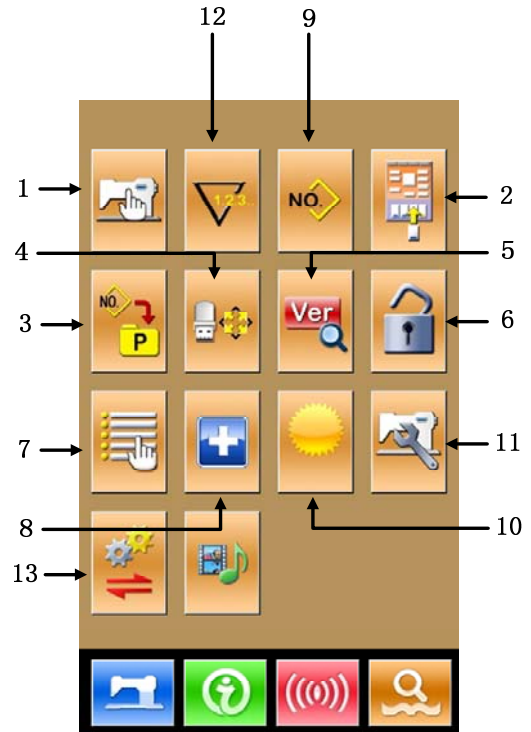

7. 1 Function List

No	Figure	Function	Remarks
1		Level 1 Parameter Setting	
2		Sewing Data Edition	
3		P Pattern Setting	
4		Initialization	
5		Software Version Inquiry	
6		Keyboard Lock	
7		User Management Setting	
8		Test Mode	
9		Sewing Type Setting	
10		Brightness Adjustment	
11		Level 2 Parameter Setting	
12		Counter Setting	
13		Parameter Back-up & Recovery	

7.2 Level 1 Parameter Setting

① Set Parameter



Select  to enter the interface of Level 1 parameter setting (shown as the figure at right).



Press  to quit the setting interface

When some parameters are changed, the system will display the “Modified” in the parameter setting interface.

Select the parameter for changing; Then the system will enter the setting status. The parameters are separated as “Data Input Type” and “Selection Type”. Please refer to the example at below:

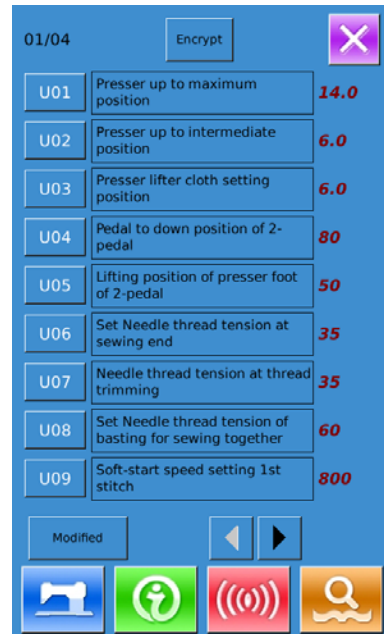

Select U01 and enter the interface below

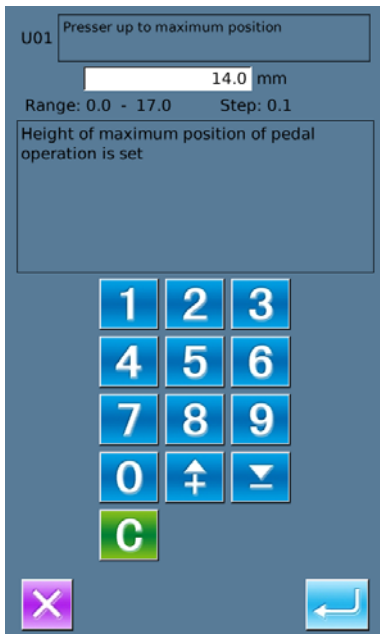

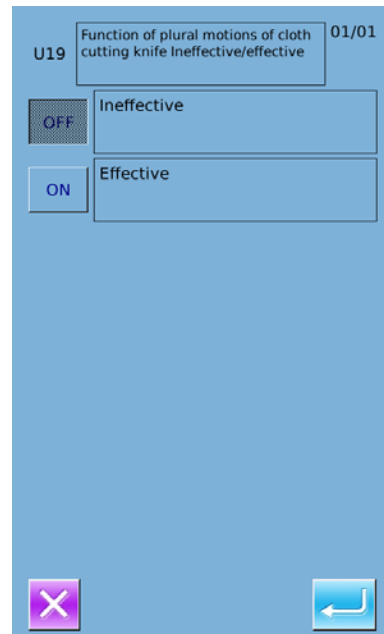

Select U19 and enter the interface below:



② **Parameter Encryption**

A、 Press “Encryption” to enter the password input interface.

Press  to clear all the content

Press  to erase one figure at each pressing

B、 Input the right password to enter the interface for parameter encryption

Select the parameter for encryption

Press **【Select All】** to attach password to all the parameters

Press**【Reverse】** to select parameter for encryption in reverse way

Press **【Change】** to change the password, the default is the manufacturer ID

Press  to quit the encrypting function

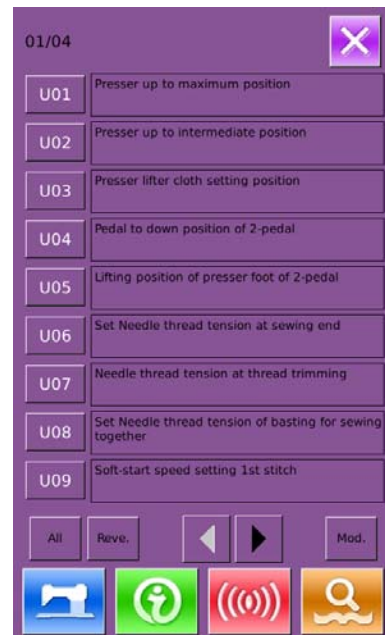
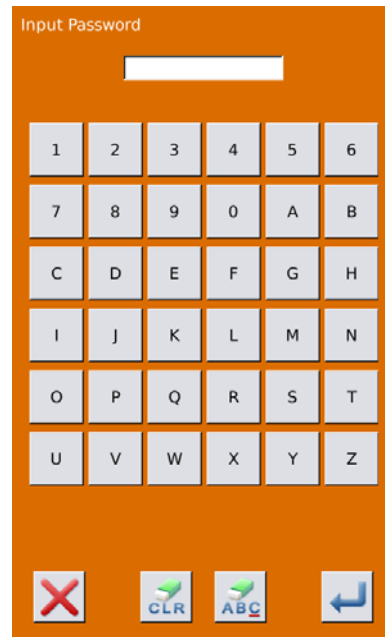

③ Check the changed parameters

A、 When parameter is changed, the system will display “Modified” key at parameter setting interface.

B、 In the parameter setting interface, press **【 Modified 】** to check the changed parameters.

At first, the system will ask user to input the password. For the operation at password input interface, please refer to the “A” at ②. After inputting the right password, user can enter the interface for inquiring changed parameters.

C、 Under the interface of changed parameter inquiry, user can find the list containing all the changed parameters with their current value and default value.

In that interface:

- Press **【 All Rest 】** will restore all the changed parameters to their default values
- Click Parameter Name, like **【 Presser Type 】** and then press **【 Select Rest. 】** to restore this parameter to the default value. User can select many parameters at here.
- Press Parameter Number, like **【 U14 】** to enter the parameter setting interface, where user can reset the parameter value.
- When the pages are more than one, user can use arrow key to turn the page.
- Press  to quit the interface.

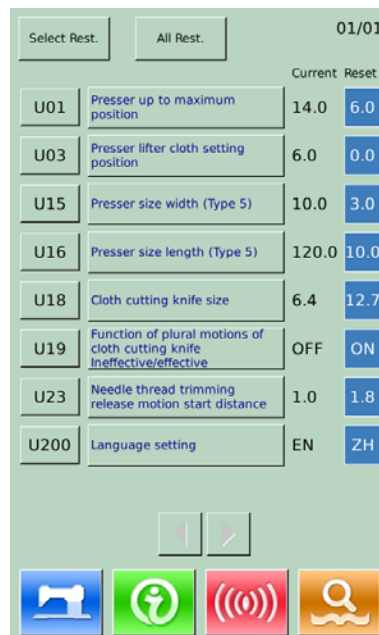

List of Level 1 Parameters

No.	Parameter	Range	Unit	Default value
U01	Presser up to maximum position Height of maximum position of pedal operation is set.	0~17.0	0.1mm	6.mm
U02	Presser up to intermediate position Height of intermediate position of pedal operation is set.	0~14.0	0.1mm	6.0mm
U03	Presser lifter cloth setting position Height of cloth at of pedal operation is set.	0~14.0	0.1mm	0
U04	Down position of 2-pedal (%) Set the operation of the 2-pedal	5~95	1%	80%

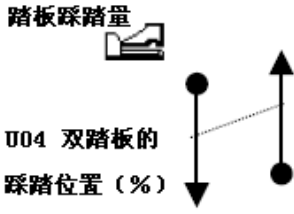
No.	Parameter	Range	Unit	Default value
U05	Lifting position of presser foot of 2-pedal Operation of 2-pedal is set 	5~95	1%	50%
U06	Set needle thread tension at sewing end	0~200	1	35
U07	Needle thread tension at thread trimming	0~200	1	35
U08	Needle thread tension at basting	0~200	1	60
U09	Soft-start speed setting 1st stitch	400~4200	100rpm	800rpm
U10	Soft-start speed setting 2nd stitch	400~4200	100rpm	800rpm
U11	Soft-start speed setting 3rd stitch	400~4200	100rpm	2000rpm
U12	Soft-start speed setting 4th stitch	400~4200	100rpm	3000rpm
U13	Soft-start speed setting 5th stitch	400~4200	100rpm	3600rpm
U14	Type of presser (Type 1, 2, 3, 5) 1: 25 x 4 2: 35 x 5 3: 41 x 5 5: User Defined	1, 2, 3, 5		Type 1
U15	Presser size width (Type 5) When U14 is set at type 5, user can input the width.	3.0~10.0	0.1mm	3.0mm
U16	Presser size width (Type 5) When U14 is set at type 5, user can input the length.	10.0~120.0	0.5mm	10.0mm
U17	Sewing start position (Feeding direction) Set the sewing start position to the presser. Set this item when starting position needs to move due to overlapped section or the like	2.5~110.0	0.1mm	2.5mm
U18	Cloth cutting knife size	3.0~32.0	0.1mm	12.7mm
U19	Function of plural motions of cloth cutting knife	ON、OFF		ON
U20	Thread Breakage Detection	ON、OFF		ON
U21	Selection of presser position at the time of ON of READY key Set presser foot position when READY key is pressed UP: Up DN: Down	UP、DN		UP
U22	Selection of presser position at sewing finish. Set presser foot position when sewing is completed. (only effective at single pedal type) UP: Up DN: Down	UP、DN		UP
U23	Needle thread trimming release motion	0~15.0	0.1mm	1.8mm

No.	Parameter	Range	Unit	Default value
	start distance Input the distance for needle thread trimmer motor to release the trimmer at sewing start.			
U24	Bobbin thread trimming release motion start distance Input the distance for bobbin thread trimmer motor to release the trimmer at sewing start.	0~15.0	0.1mm	1.5mm
U25	Counter updating unit Update Unit in sewing counter	1~30	1	1
U26	Forbid Changes at Counter	ON、 OFF		OFF
U27	Operation of machine at counter reaching set value	ON 、 OFF		OFF
U50	Voice of Buzzer OFF: Buzzer off PAN: Control Panel Voice available ALL: Voice of Control Panel and buzzer available	OFF、 PAN、 ALL		ALL
U100	Back Light Auto Off OFF: No Auto Off ON: Auto Off	ON、 OFF		OFF
U101	Back Light Off Wait Time	1~9	1	3s
U200	Language Setting	Chinese, English, Turkish		Chinese
U201	Select Language at Power-on	ON、 OFF		OFF

7.3 Level 2 Parameters Setting

① Set Parameter

In the interface of Mode Setting Level 3, press  to enter the interface for setting parameters of Level 2 (as shown in the right figure). For the operation methods, please take the description in 7.2 Level 1 Parameter Setting for reference

When some parameters are changed, the system will display the “Modified” in the parameter setting interface.

Press  to quit the parameter setting interface

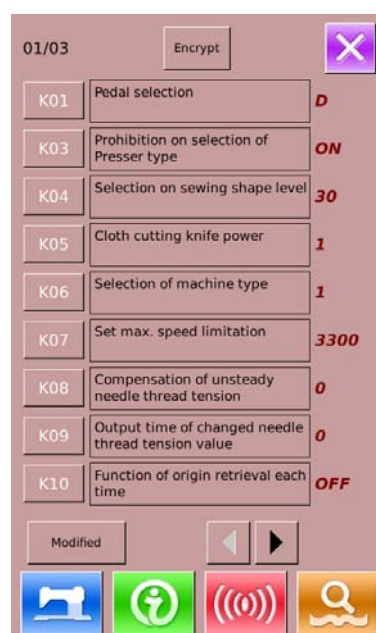

② Parameter Encryption

For the steps of the parameter encryption, please refer to “7.2 Level 1 Parameter Setting”.

Press  to quit the parameter encryption interface.

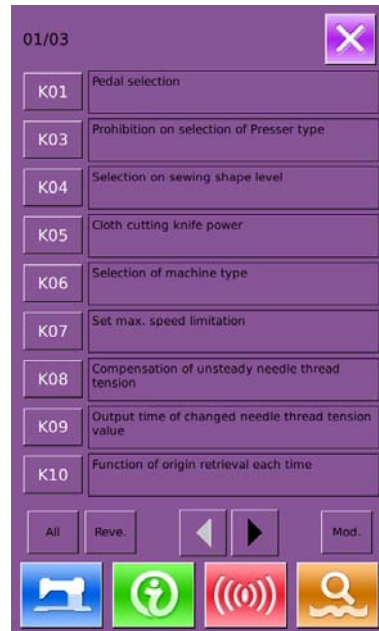

③ Check the changed parameters

When parameter is changed, the system will display “Modified” key at parameter setting interface

In the parameter setting interface, press **【Modified】** to check the changed parameters.

User can also reset the parameters here.

For the specific operation, please refer to “7.2 Level 1 Parameter Setting”

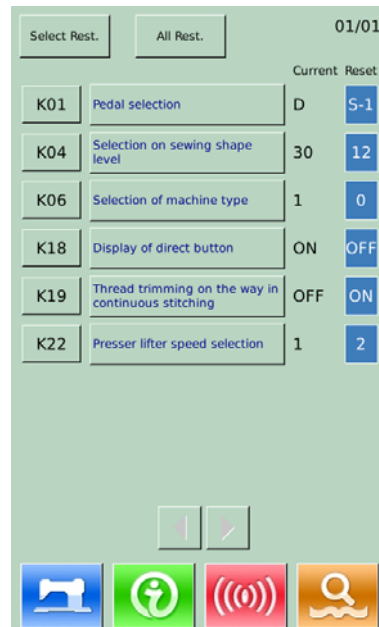

List of Level 2 Parameter

No.	Parameter	Range	Unit	Default value
K01	Pedal Selection D: Double Pedal S-1: Single Pedal (No middle position) S-2: Single Pedal (With middle position)	D、S-1、S-2		S-1
K03	Prohibition on selection of Presser type OFF: Prohibit to change ON: Permit to change	ON、OFF		ON
K04	Selection on sewing shape level (12/20/30)	0~2		0
K05	Cloth cutting knife power Set output power of cloth cutting knife	0~3	1	0

No.	Parameter	Range	Unit	Default value
K06	Selection of machine type (0-Standard type, 1-Non-oil Type)	0~1	1	0
K07	Set max. speed limitation When K06 Selection of machine type is set to non-oil type, max speed is automatically limited to 3,300 rpm. ※Protected by password	400~4200	100rpm	3600rpm
K08	Compensation of unsteady needle thread tension Output value of needle thread tension is wholly compensated.	-30~30	1	0
K09	Output time of changed needle thread tension value When data related to needle thread tension is changed, the changed value is output only at the set-up time.	0~20	1s	0
K10	Search origin at each time Search origin at each sewing end OFF: NO 1: After Sewing End 2: After Cycle End	OFF、1、2		OFF
K11	Needle up by reverse run When U01 Presser lifter maximum position is set to 14.0 mm or more, needle can be lifted by reverse run automatically and the machine stops. Prohibition of the motion can be set OFF: Forbidden ON: Permitted	ON、OFF		ON
K12	Set knife solenoid lowering time	25~100	5ms	35
K13	Set knife solenoid lifting time	5~100	5ms	15
K14	Knife cylinder lowering time (Optional)	5~300	5ms	50
K15	Y-feed motor origin compensation	-120~400	1 Pulse (0.025mm)	0
K16	Needle-rocking motor origin compensation	-10~10	1 Pulse (0.05mm)	0
K17	Presser lifter motor origin compensation	-100~10	1 Pulse (0.05mm)	0
K18	Display of direct button OFF: Not Display ON: Display	ON、OFF		OFF
K19	Thread trimming on the way in continuous stitching In case of prohibited, jump feed setting becomes invalid, and the registered pattern is sewn at the same position. Then multi-sewing is possible OFF: Prohibition ON: Permission	ON、OFF		ON
K20	Change of cloth cutting knife return power This item sets output power at the time of returning the cloth cutting knife.	0~3	1	0
K21	Release amount of bobbin thread trimmer at the start of sewing This item sets the amount of releasing the bobbin thread trimmer at the start of sewing.	1~15	1Pulse	8

No.	Parameter	Range	Unit	Default value
K22	Presser lifter speed selection	1~3	1	1
K189	Adjustment of Thread-breakage Detection Sensitivity	1~10	1	3
K190	Adjustment on sensitivity of button	1~5	1	3
K200	Restore to original parameters ※ Protected by Password			

7. 4 Counter Setting



Press to enter the interface for counter setting(as shown in the right figure)

Operation Steps:

① Select Sewing Counter Type

Select Sewing Counter or No. of Pcs Counter

② Set the Current Value and Setting Value

At the selected type, press the “Current” or “Setting” to perform the relating operation.

③ Select Up Counter or Down Counter

At the selected type, please press “Up” and “Down” to perform the relating operations.



Press to quit counter setting interface



Press to finish setting and quit.

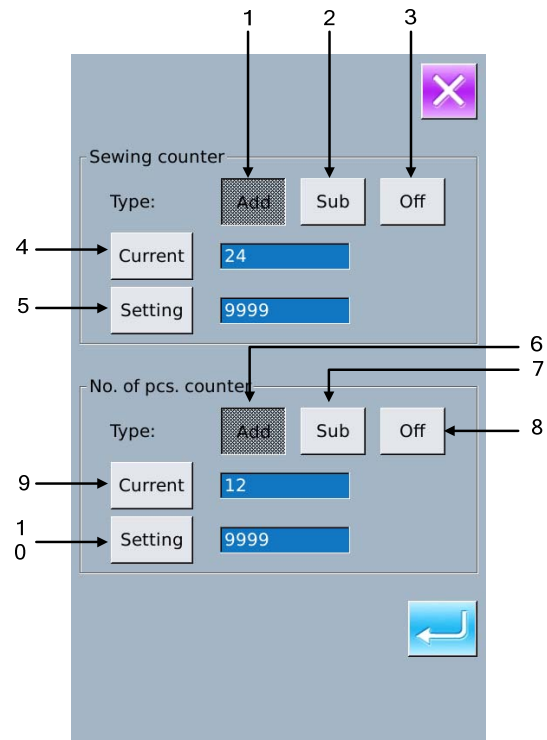

Sewing UP Counter :

Every time the sewing of one shape is performed, the existing value is counted up 1. When the existing value is equal to the set value, the interface of counter exceed warning will be displayed. Press to restore the existing value to 0

Sewing DOWN Counter :

Every time the sewing of one shape is performed, the existing value is counted down 1. When the existing value is reached to "0", the interface of counter exceed warning will be displayed. Press to restore the existing value to the set value.

No of piece UP counter :

Every time a cyclic sewing or a continuous sewing is performed, the existing value is counted up 1. When the existing value is equal to the set value, the interface

of counter exceed warning will be displayed. Press



to restore the existing value to 0

No of piece DOWN counter:

Every time a cyclic sewing or a continuous sewing is performed, the existing value is counted down 1. When the existing value is reached to "0", the interface of counter exceed warning will be displayed. Press  to restore the existing value to the set value.

④ Turn Off Counter

At the selected counter type, press "Off" to turn off the counter

7. 4. 1 Functions

No.	Function	Remarks
1	Sewing Add Counter	
2	Sewing Down Counter	
3	Sewing Counter Off	
4	Set Current Sewing Counter Value	
5	Set the Setting Value of Sewing Counter	
6	No.of Pcs Add Counter	
7	No.of Pcs Down Counter	
8	No.of Pcs Counter Off	
9	Set Current No.of Pcs Counter Value	
10	Set the Setting Value of No.of Pcs Counter	

7.5 Settings on User Management

Register parameters which are frequently used to Management button and use them.



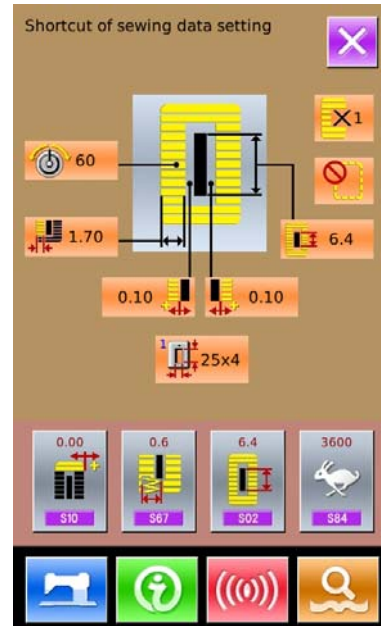

Press  to enter user management setting interface (shown as the right figure)



① Register to Management Button

The management buttons can be registered up to four buttons. Four management register buttons are displayed on the screen. When the button located on the position you desire to register is pressed, the sewing data selection screen is displayed. (as shown in right figure)

Press  to quit the interface for setting the customer management.

Select the sewing data you wish to register, press  to end the operation of registration. The newly registered sewing data will be displayed on the user management button

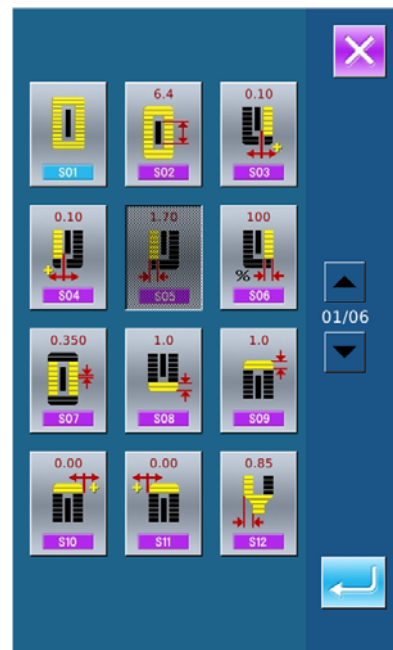

② Original State of Registration

The following items have been registered in order (from the left to the right) at the time of your purchase



S07 : Pitch at parallel section;

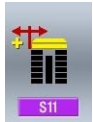

S11 : Compensation of bar-tacking width, left



S10 : Compensation of bar-tacking width, right;



S57 : Setting of needle thread tension at the start of sewing

7. 6 Edition of Sewing Data



Some sewing data can be set to be opened, press to enter the interface of sewing data edition under the Mode Setting Level 2 (as shown in the right figure)





S20 : Sewing data is opened



S20 : Sewing data is closed

Select the sewing you wish to edit. When the button is pressed, the interface will be shifted between reverse

display/non- display. After pressing  , the user can confirm whether the sewing data item is in state of opening

Press  to quit the Sewing Data Edition Interface.

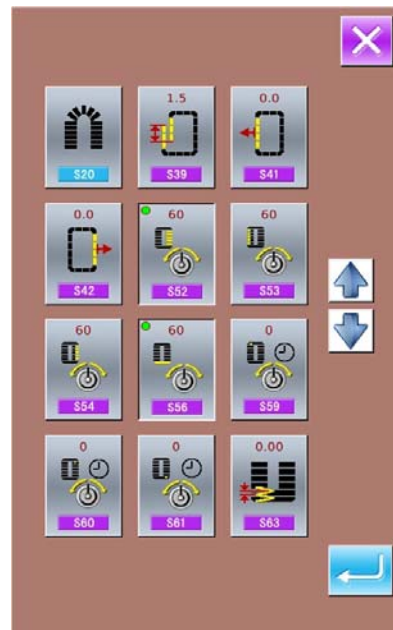

7.7 Change Sewing Mode



Press  to enter the interface of sewing type selection (as shown in the right figure).



: Normal Sewing





: Continuous Sewing



: Cyclic Sewing

After confirming the sewing type, press  to end the

operation. Press , then the data input interface of the selected sewing type is displayed.

Press  to quit and the original sewing remains.

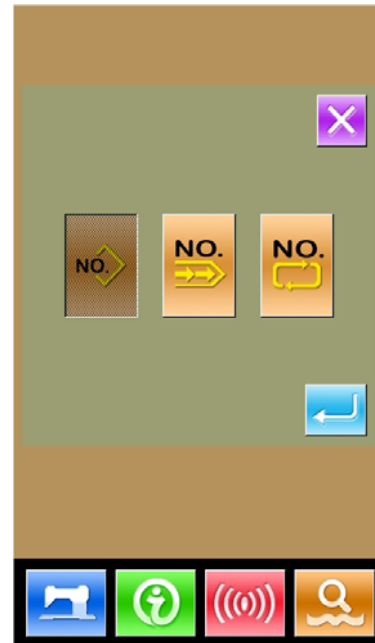

7.8 Register Pattern to Direct Button

Register the pattern numbers which are frequently used with the direct buttons for use.



Press  to enter the interface of direct button registration (as shown in right figure).



Press  to quit the Pattern Registration Function

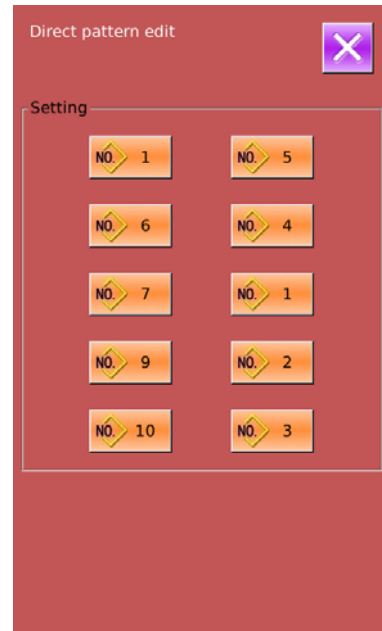

10 pattern numbers can be registered to the direct buttons at most. On 10 displayed direct buttons, the user presses the button he wishes to register, and then enters the pattern select interface. (as shown in the right figure)

The file in blue is the file in VDT format

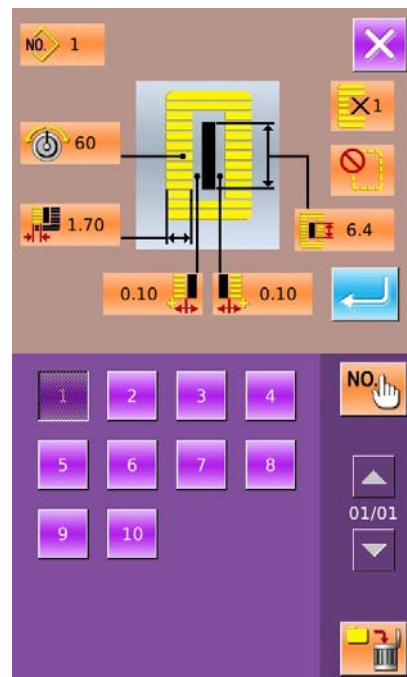

: Pattern Inquiry



: Delete Current Registered Pattern



: Confirm



: Quit

7.9 Test Mode

In the Mode Setting Level 2 interface, press  to enter the interface of Test Mode (as shown in right) .

The function of each figure is shown as below:

No.	Name
A	I01 Needle thread trimming
B	I02 Down thread trimming
C	I03 Input inspection
D	I04 Inspection of LCD display
E	I05 Correction of touch panel
F	I06 Output inspection
G	I07 Speed test
H	I08 Continuous running

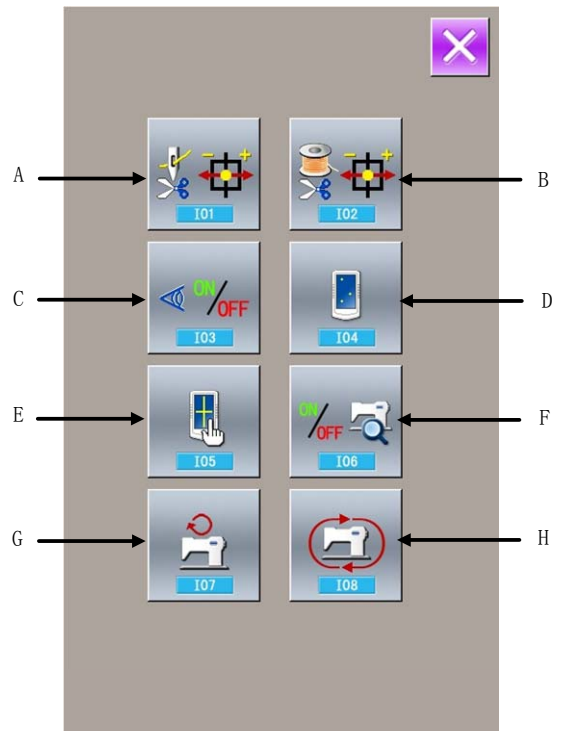

Press  to quit Test Mode

(1) Adjustment of Needle Thread Trimming

① Adjusting Method

In the interface of Test Mode, press  (I01 Needle thread trimming) to enter the adjustment interface of needle thread trimming (as shown in the right figure):

Needle Thread Trimming:

No.	Name	Range	Initial value
A	Origin position		
B	Initial position	-10~10	0
C	Releasing position	-95~-80	-86
D	Position for trimming	0~20	10
E	Post-trimming position	30~50	40

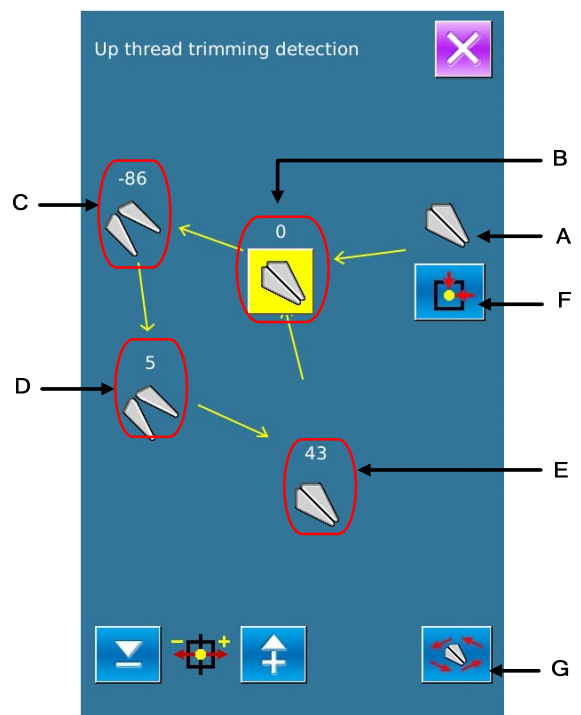

② Select the mode position you wish to adjust

Press  G to select the positions (A, B, C, D) for

adjustment, then press the  /  key to adjust the

necessary value, at last press  F to return to the origin.

③ Press  to return to the Test Mode Interface

(2) Adjustment of Down Thread Trimmer

① Adjusting Method



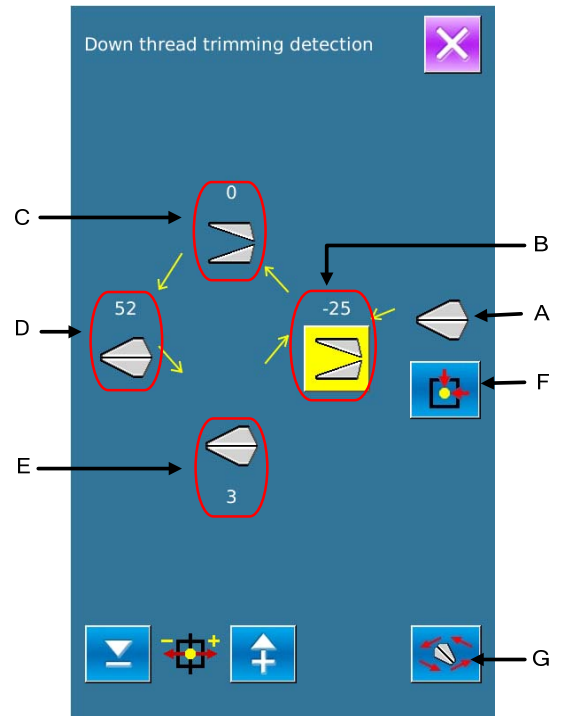

In the interface of Test Mode, press  (I02 Down thread trimming) to enter the adjustment interface of Down thread trimming (as shown in the right figure):

Down Thread Trimming:

No.	Name	Range	Initial value
A	Origin position		
B	Releasing position	-40~-15	-22
C	Position for trimming	-10~10	0
D	Trimming position	40~60	50
E	Initial Position	-10~15	0



④ Select the mode position you wish to adjust

Press  G to select the positions (A, B, C, D) for adjustment, then press the  /  key to adjust the necessary value, at last press  F to return to the origin

Press  to return to Test Mode Interface.

(3) Input Signal Test Method

In the interface of Test Mode, press  (I03 Input Inspection) to enter the interface of input inspection interface (as shown in right). Users can confirm the input status of each switch and sensor.

ON: Turn On

OFF: Turn Off

A: mount of pedal pressed

B: Pedal Sensor

C: Thread-breakage Detection

D: Knife Sensor

- E: Head Tilt Sensor
- F: Stop Switch
- G: Needle Rocking Sensor
- H: Semi-lunar Sensor of Sewing Machine
- I: Y Feeding Origin
- J: Presser Origin
- K: Needle Thread Trimming Motor Origin
- L: Bobbin Thread Trimmer Motor Origin

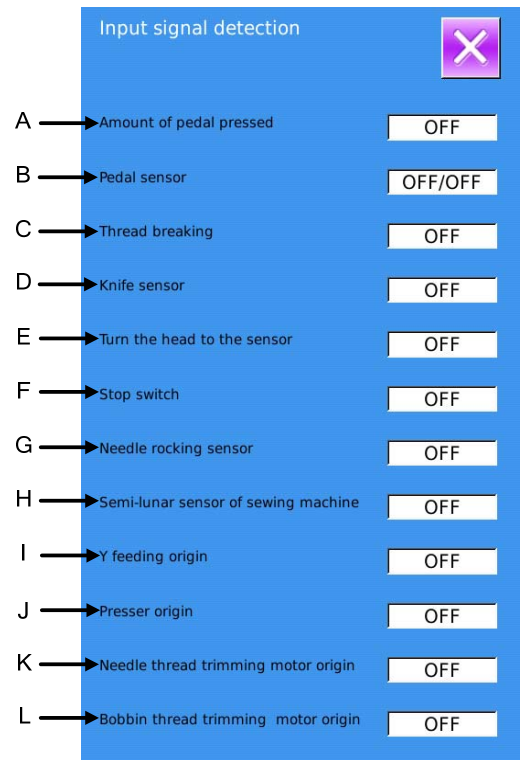

(4) Inspection of LCD Display



In the interface of Mode Inspection, press  (I04 Inspection of LCD Display) to enter the interface of LCD Display Inspection (as shown in right figure). Check whether the LCD fades in that status.

Touch the panel to have the screen display in the cycle of “Blue — Black — Red — Green — White”.

Press  to quit the interface of LCD Display Inspection



(5) Correction of Touching Panel

A、 In the interface of Mode Inspection, Press  (I05 Correction of Touch Panel). Then system will hint user 【Enter Touching Panel Correction Mode?】. Press  to enter the interface for Touch Panel Correction (as shown in right figure). Press  to quit the correction status.

B、 Because the corrections for five spots are needed, the user had better click the cross icon on the screen with tools like touching pen. After the correction, the system will tell user that this operation is successful or not.

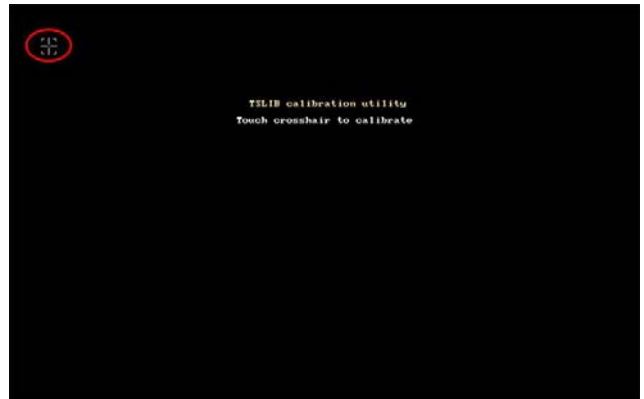



※ **During the correction, please do perform the operation according to the positions of crosses. Otherwise, the touching panel will be unable to work normally after the correction.**

(6) Output Inspection

In the interface of Mode Inspection, Press  (I06 Output Inspection) to enter the interface of Output Inspection (as shown in the right figure). The following output status of the solenoid can be checked under that interface. :

- A: Needle-rocking Motor Test
- B: Presser Motor Test
- C: Bobbin Thread-trimming Motor Test
- D: Cloth-feeding Motor Test
- E: Needle Thread Motor Test
- F: Tension Solenoid
- G: Knife Solenoid

- When user presses A~E, the system will display . Press【+】and【-】to display the motor origin test status.
- At user pressing F~G, the corresponding solenoid will move
- Press  to quit output inspection interface

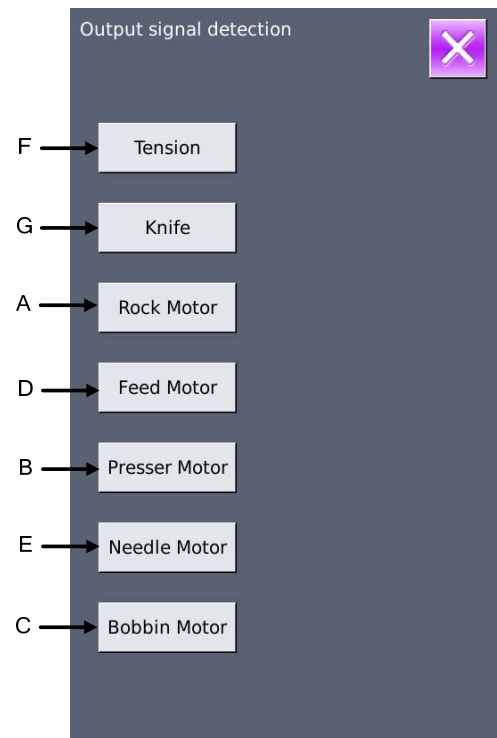

※ **Attention: Sewing machine will perform relating actions.**

(7) Speed Test

① Interface for Speed Test

In the interface of Mode Inspection, Press  (I07speed test) to enter the interface for Speed Test (as shown in right figure). The speed of main shaft motor can be tested in that interface.

Press  to quit the speed test interface.

② Continuous running setting

Press “+” & “-” to set the speed of the main shaft motor.

Press , then the motor will run at the set speed. At this moment, the actual tested speed is displayed in the interface.

Press  to stop the machine.

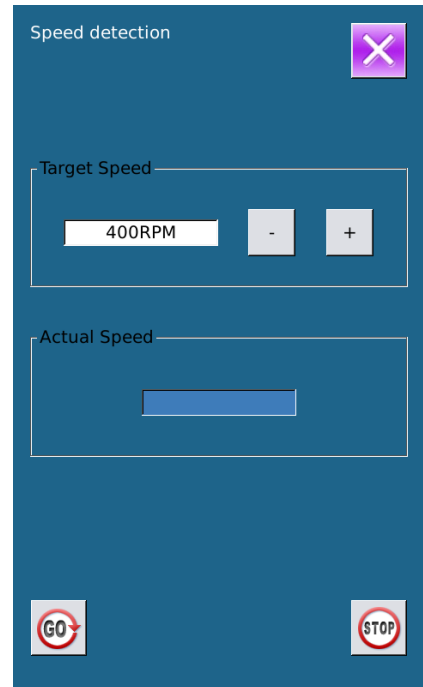

(8) Continuous Running

① Display the interface for continuous running

In the interface of Mode Inspection, Press  (I08 continuous running) to enter the interface of continuous running (as shown in right figure).

- A: Action interval
- B: Origin Detection

Press  to quit that interface.



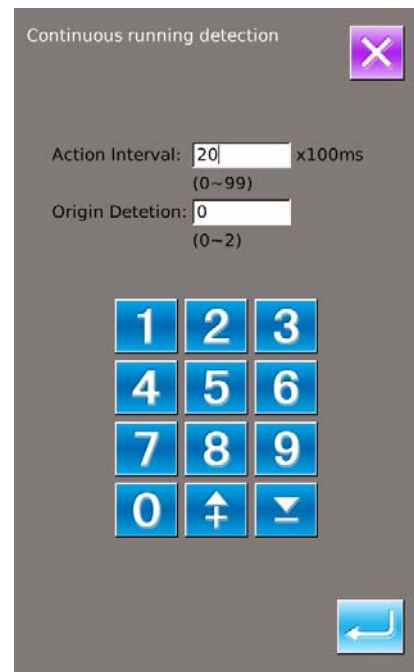

② Continuous running setting

Click the columns under the interface of Continuous Running to set the Action interval and Origin Detection. Set the value with the number keys.

Press  and step the pedal to start the continuous running. During the running, user can use the pause switch to stop machine or he can stop machine by stepping the pedal or pressing pause switch at action end



7. 10 Brightness Adjustment

In the Mode Setting Level 2 interface, press  to enter the interface for brightness adjustment (as shown in right figure), the brightness value can be adjusted from 20 to 100 by pressing  or , it also can be adjusted by inputting the value via keyboard. Press  to finish the input. Press  to quit that interface

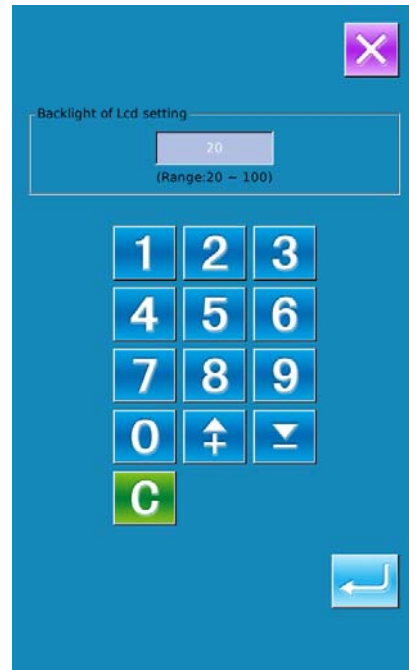



7. 11 Operation of Keyboard Lock

In the Mode Setting Level 2 interface, press  to enter the interface of Keyboard Lock Setting.

① Lock the keyboard

 : Keyboard unlocked

 : Keyboard locked

Press  and  to lock the keyboard. Press  to quit this interface

② Display of locking keyboard status

Close the interface of parameter setting mode, and return to the data input interface, like right figure. We can see there is a figure to show the locking status 

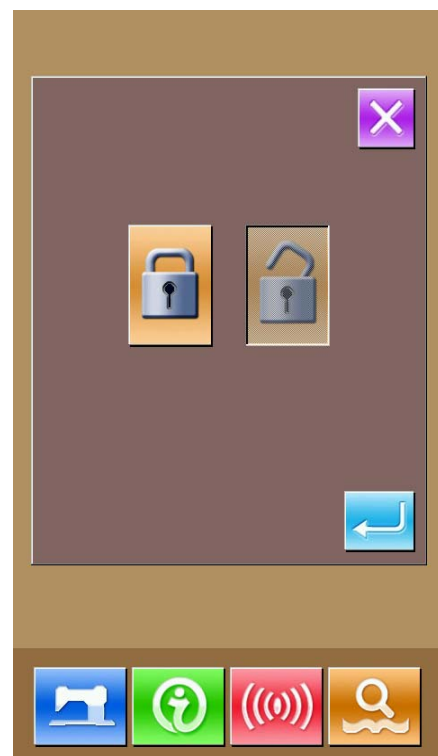

under the pattern number. Only can the available figures shown under the status of keyboard locking.

③ Scope of locking keyboard

1. Normal sewing data input interface:

- 1) Pattern Registration
- 2) Pattern Copy
- 3) Pattern Naming
- 4) Customer Management
- 5) Presser Selection
- 6) Shape and Relevant Sewing Data

2. Normal Sewing Interface:

- 1) Counter Setting
- 2) Needle Thread Tension Setting

3. Continuous Sewing data input interface:

- 1) Pattern Registration
- 2) Pattern Copy
- 3) Pattern Naming
- 4) Cloth Feeding Amount
- 5) Deletion
- 6) Pattern Sewing Data

4. Continuous Sewing Interface:

- 1) Counter Setting
- 2) Needle Thread Tension Setting

5. Cyclic Sewing Data Input Interface:

- 1) Pattern Registration
- 2) Pattern Copy
- 3) Pattern Naming
- 4) Deletion
- 5) Delete All
- 6) Sewing Fabric
- 7) Sub-pattern Registration

6. Cyclic Sewing Interface:

- 1) Counter Setting
- 2) Needle Thread Tension Setting

7. Parameter Setting Mode:

- 1) Parameter Level 1
- 2) Parameter Level 2
- 3) P Pattern Edition
- 4) Customer Management
- 5) Sewing Data Edition
- 6) Inspection Mode
- 7) Counter Edition

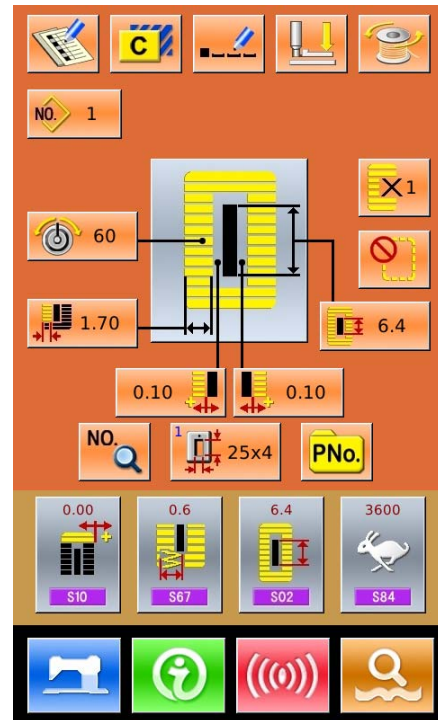

7. 12 Initialization



Press  to enter the interface for setting the keyboard lock.

In this interface, user can operate:

- U Disk Initialization
- Memory Initialization
- Customized Initialization

Press the relating functions keys and enter the corresponding interface.

Press  to quit.

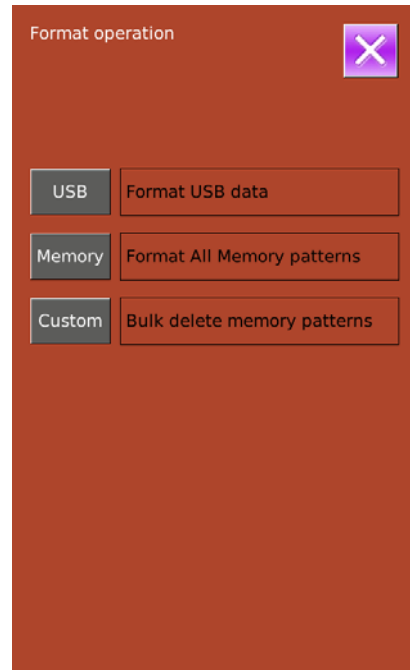

① Press “USB” to Initialize U Disk Files

Press  to initialize all the U disk files

Press  to quit U disk initialization

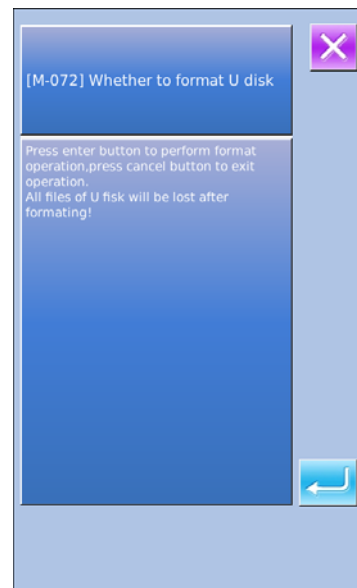

② Press “Memory” to initialize memory patterns

The following patterns can be initialized:

- Normal Pattern
- Continuous Sewing Pattern
- Cyclic Sewing Pattern
- Registered P Pattern

Press  to initialize all the files in memory

Press  to quit

※ **Caution! This operation will delete all the patterns within the memory!**

③ Press “Custom” to perform the batch deletion

In this interface, the system will display all the pattern files within the memory. Click the corresponding button to perform the batch deletion.

Operations at this function:

- A. Use “Up Arrow”, “Down Arrow” to turn the page
- B. Use the following three operations to select patterns

- Press  to select all the patterns

- Press  to select pattern in contrary way
- Input pattern number

C. Press  to delete the patterns in batch

D. Press  to quit Initialization Interface

※**The files with blue mark are in vdt format.**

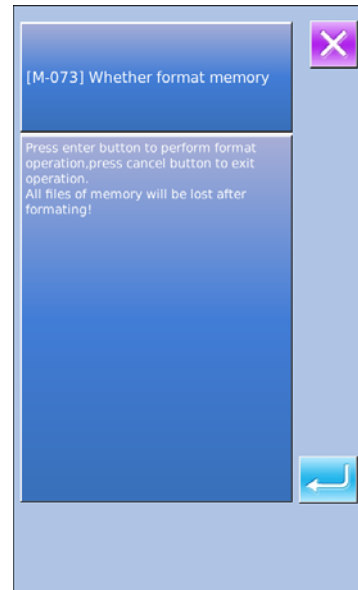

④ Under the Interface of Custom Initialization,

press  to display the free room of the memory and the number of patterns in each format.

Press  to return to the upper interface.

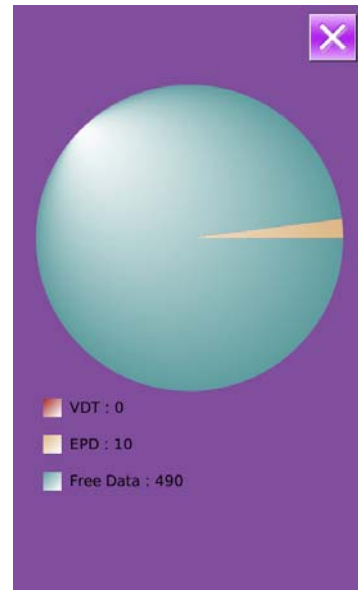

7. 13 Parameter Back-up & Restoration



In order to use in future, user can save 8 groups of U level parameters according to needs

In setting mode level 2, press  to enter the interface of parameter back-up & restoration, as shown in right:

Clear: Clear all the customized parameters that are saved.

Save: Save current parameters

Restore: Restore the current parameters

① Click and key among  ~  to set the position for saving the parameter. And then press 「 Save 」 to save that parameter.

② Check the content on「 User xx(On/Off)」. If 「 On 」 is displayed in bracket, that means this position has the user parameter, for an example .

③ Select the button with parameters, press 「 Restore 」 to reload the corresponding parameter values

④ Press 「 Clear 」 to delete all the saved parameters.

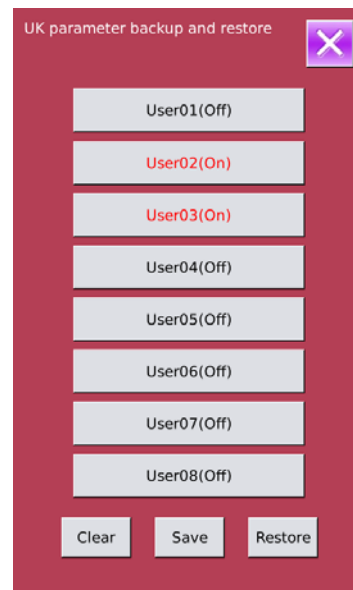

8 Communication

At Communication, user can perform the following functions:

- Download the sewing data made at other sewing machines or produced by the pattern-designing software to the sewing machine;
- Load sewing data to U disk or computer
- Load parameters from U disk
- Input the parameters within the operation panel to U disk
- Update the software within the operation panel

8.1 About the Available Data

The following two kinds of sewing data are available for operation; please check their formats in the form below:

Name	Suffix	Content
Vector Data	[0-9][0-9][1-9].vdt	Needle entry point data
Parameter Data	[0-9][0-9][1-9]. epd	Sewing shape designed in sewing machine。

When saving data to the U disk, user needs save it to the DH_PAT folder. Otherwise, the file is unable to be read.

8.2 Operations

① Display the Communication Interface

In the data input interface, press  to display the communication interface.

② Select the relating operations

The following three kinds of functions can be selected in this interface:

- Pattern Transfer
- Parameter Transfer
- Software Update

Click the corresponding figure to perform the operations

③ Press to quit the Communication



8.3 Pattern Transfer

① Display the Communication Interface

In communication interface, press:

- A: Input patterns from U Disk to Operation Panel
- B: Output patterns from Operation Panel to U Disk

Path of U Disk: DH_PAT

- ※ When inputting patterns from U disk, user has to save the pattern into the DH_PAT in the U disk.
- ※ When outputting patterns from operation panel, user has to save the pattern into the DH_PAT in the U disk
- ※ Naming Method of Patterns within U Disk

When inputting patterns from U disk, user needs follow the naming rule at below::

File Name: 3 figures, 001~500

Suffix: epd、vdt

Example:



Right Names: 001.epd、100.vdt、003.EPD、102.VDT

Other naming methods are wrong, which can not be recognized by machine

② Press button A to enter the interface for inputting patterns from U Disk

A、Use【Up Arrow】、【Down Arrow】to turn the page

B、Use these three methods to select patterns

- Press  to select all the patterns
- Press  to select in contrary way
- Input Pattern Number

C、Press  to finish pattern input

D、Press  to delete the selected pattern

E、Press  to quit Communication Interface

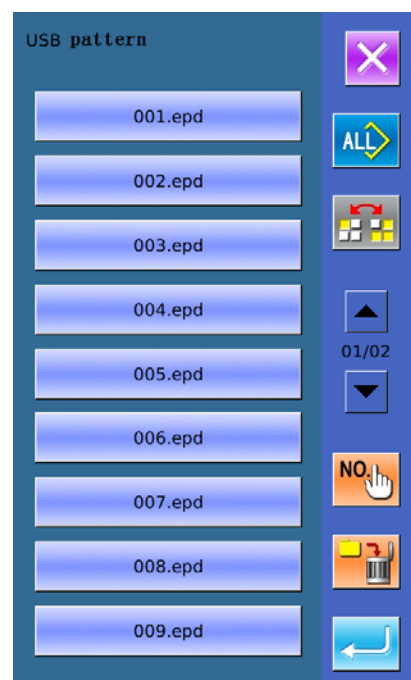
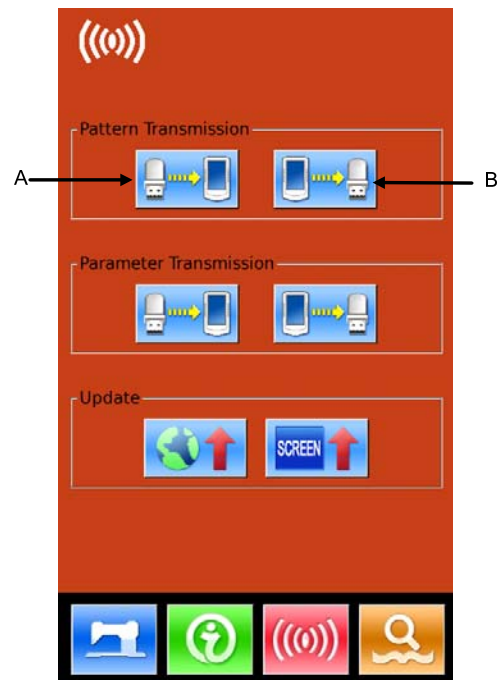

F、 Press  to display the interface shown at right.

Input the pattern number for saving;

Press  to copy the selected pattern within U Disk and save it to the pointed pattern number and return to the upper interface

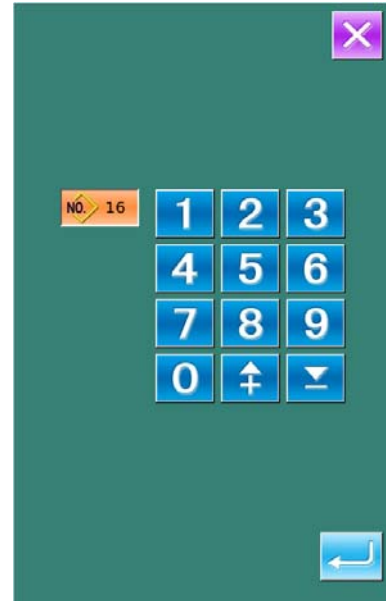

Press  to quit.





③ Press Button B to enter the interface for inputting patterns to U Disk.

A、 Use **【Up Arrow】** , **【Down Arrow】** to turn the page

B、 Use these three methods to select patterns

- Press  to select all the patterns
- Press  to select in contrary way
- Input Pattern Number

C、 Press  to delete the selected pattern

D、 Press  to finish pattern output

E、 Press  to quit Communication Interface

F、 In this interface, press  to display the free room of the memory and the number of patterns in each format.

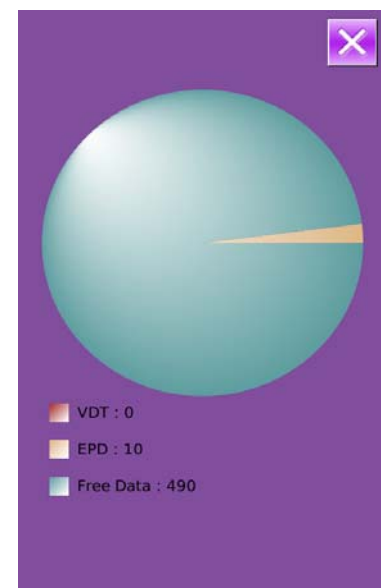

※ The files with blue mark are in vdt format

8. 4 Parameter Transfer

① Display the Communication Interface

In communication interface, press:

A: Input parameters from U Disk to Operation Panel

B: Output parameters from Operation Panel to U Disk

- ※ When inputting patterns from U disk, user has to save the parameters into the DH_PARA in the U disk with name PS_Param.
- ※ When outputting patterns from operation panel, user has to save the parameters into the DH_PARA in the U disk with name PS_Param.
- ※ The parameter file is the binary file, which is operated on the control panel. User can not change that file manually on PC, or the file may be damaged.

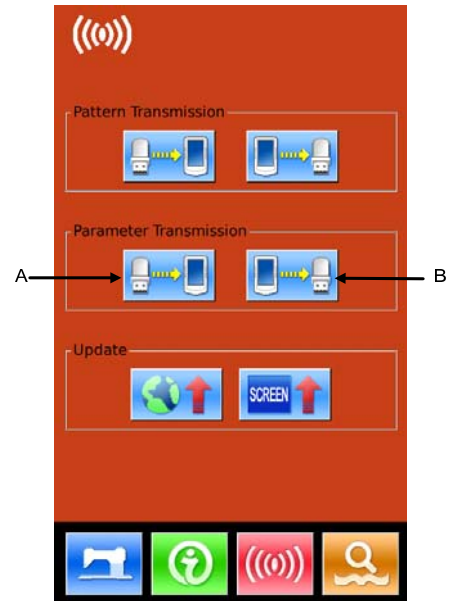

② Press Button A to Input Parameters from U Disk to Operation Panel

A、 Press  to input the parameters and quit

B、 Press  to quit directly.

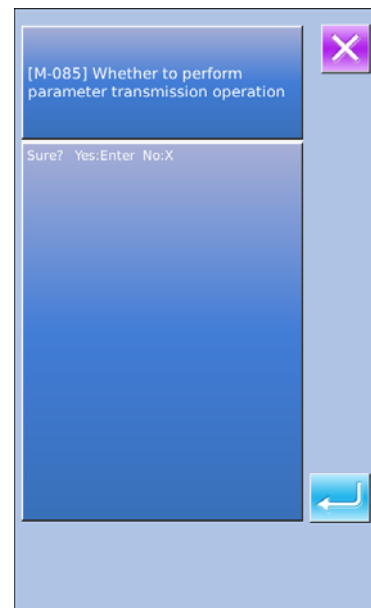

③ Press Button B to Output Parameters to U Disk

A、 Press  to output parameters from operation panel to U disk and quit

B、 Press  to quit directly

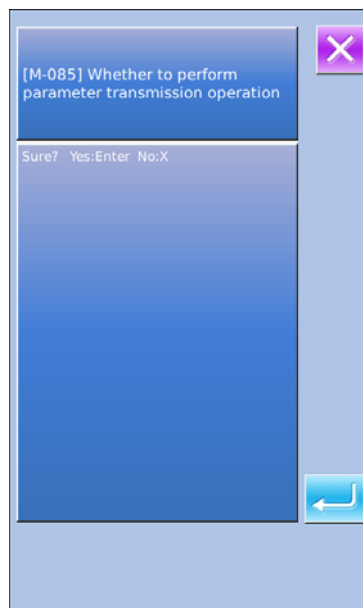

8.5 Software Update

① Display the Interface

In Communication interface, press A to enter Software Update Interface

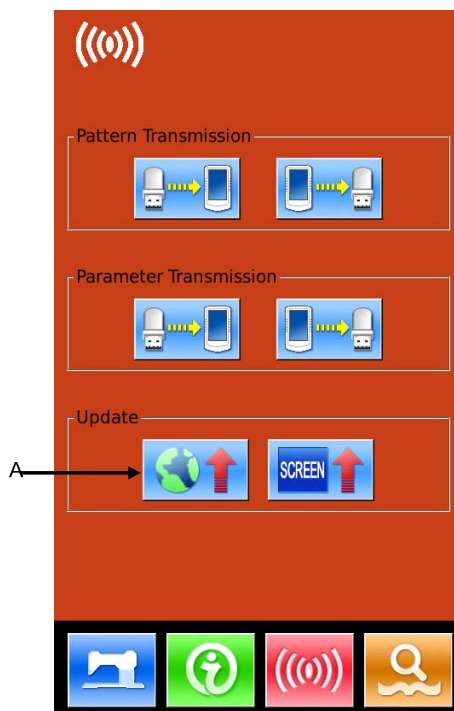

② Update Selection

The software update contains:

- ◆ Operation Panel Software
- ◆ Icon
- ◆ Font
- ◆ Power-on Screen

Press  and  to turn the page

A、 Press  to finish the selected update and quit

B、 press  to quit directly

C、 User can select several items for update at same time. The system will perform the update according to the order

D、 After the update, please restart the machine

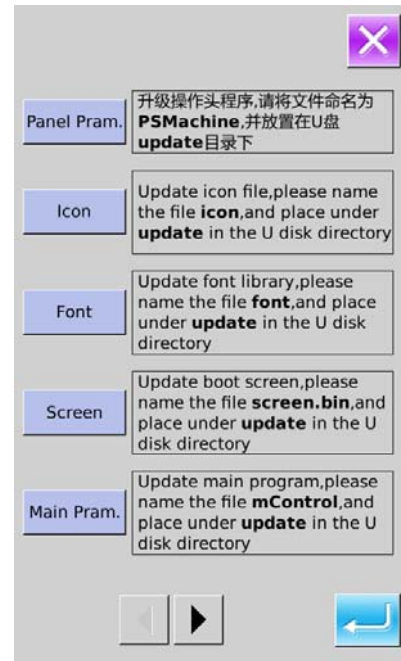

9 Information

There are three functions in the information function as below

- 1) Oil replacement time, needle replacement time, cleaning time and so on, are designated and the warning notice is performed when the designated time has passed;
- 2) Speed can be checked at a glance, and the target achieving consciousness of group is increased as well, by using the function to display the target value and the actual value.
- 3) Display the threading

9.1 Check the Maintenance Information

① Display the information interface

In the data input interface, press the information key (A) the interface of information will be displayed.

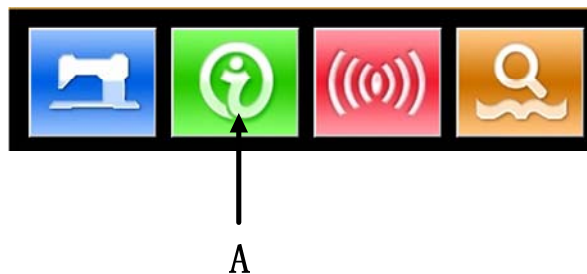

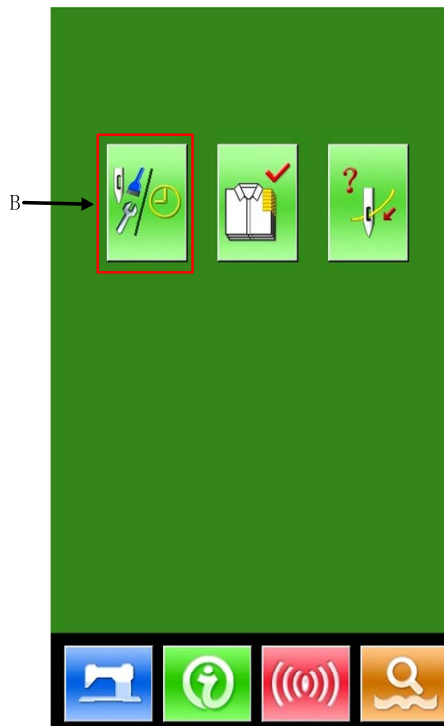

② Display the maintenance interface.

Please press button  (B) 。



Information on the following three items is displayed in the maintenance information interface.

 : Needle replacement (1,000 stitches)

 : Cleaning time (hour)

 : Oil replacement time (hour)

Each item is displayed as C. The time interval is displayed at D, while remaining time is displayed at E

The remaining time can be cleared, by pressing the corresponding button.

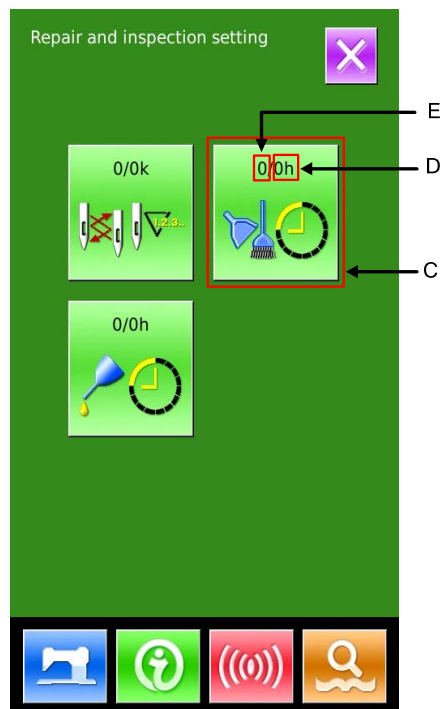

Press  to quit to information interface

9. 2 Set the Maintenance Time

① Display the information interface (maintenance personnel level)

In the data input interface, hold the information key (A) for 3 second, the interface of information (maintenance level) will be displaced. In the interface, 6 keys are displayed.

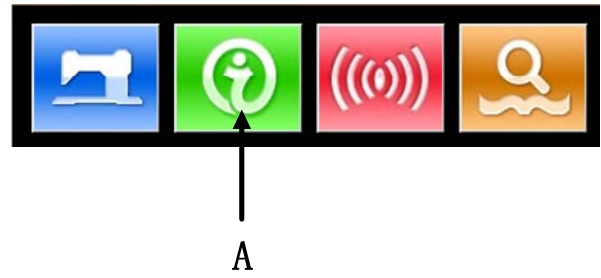

② Functions Displayed

At maintenance level, 6 functions are displayed

-  : Maintenance
-  : Production Control
-  : Threading
-  : Warning Record
-  : Running Record
-  : Periodical Password

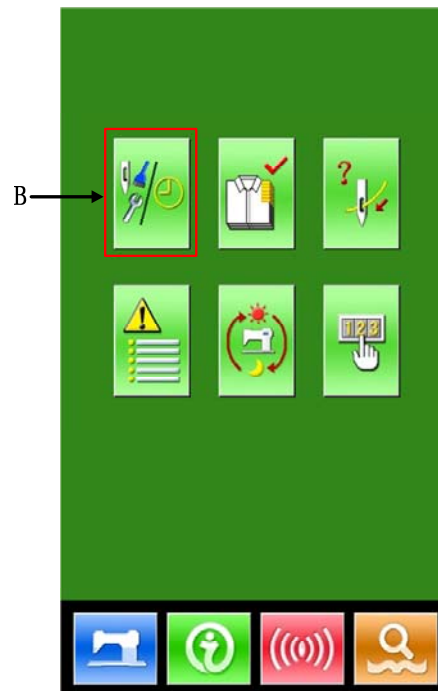

Please press the Maintenance Button  (B) to enter the maintenance interface.

③ Maintenance Setting

In the maintenance information interface, the same information as that in the normal maintenance interface is displayed. Press button (C) to activate the relating input interface.

Press  to set the time for cleaning.

Press  to quit to information interface

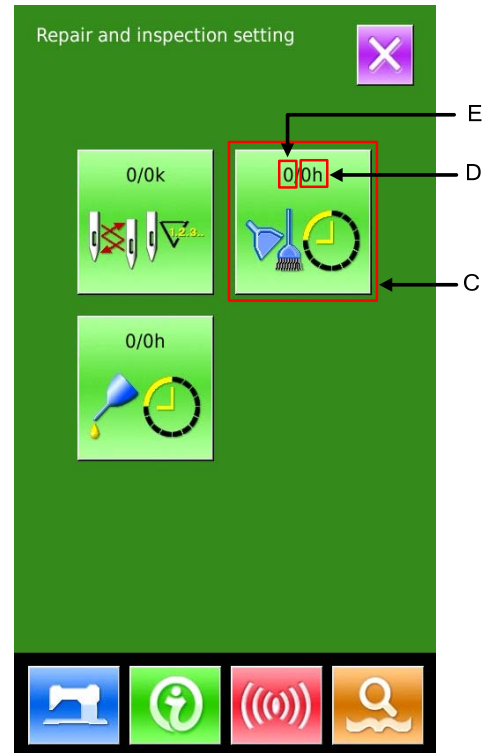

④ Set item for maintenance

Set the set value of the maintenance item at 0, the system will stop the function of maintenance.

The items of maintenance include:

- ◆ Needle Replacement Time
- ◆ Cleaning Time
- ◆ Oil Replacement Time

Press the figure to enter the relating interface:

A、 Use number keys to input the set value of these items.

B、 Press  to confirm the input.

C、 Press  to quit to maintenance interface.

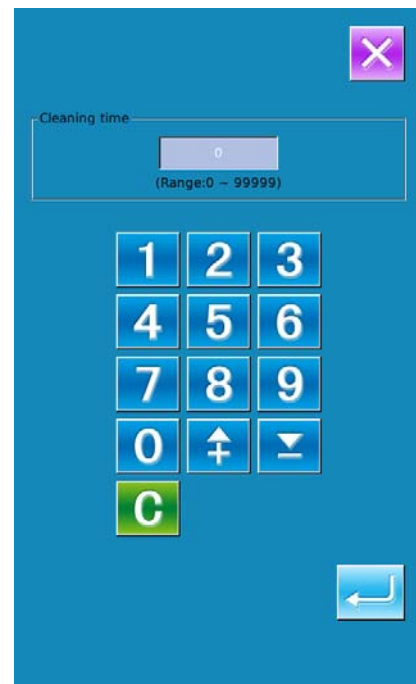

9.3 Method to Release the Warning

When the designated inspection time is reached, the warning interface is coming out. Press  to release the warning. Before releasing the maintenance and repair time, the information warning interface will come out upon the complete of each stitch.

The following are the warning code for each item:

- Needle Replacement : M031
- Oil Replacement Time: M032
- Cleaning Time : M033

9. 4 Information of Production Control

In the production control interface, the system can display the number of production from the start to present and the target number of production, as long as, receiving the start order. There are two ways to enter the interface of production control as below: :

- Via Information Interface
- Via Sewing Interface

9. 4. 1 Via Information Interface

① Display of information interface

Press the Information Key (A) locating at the switch part in the data input interface, then the system will display the information interface.

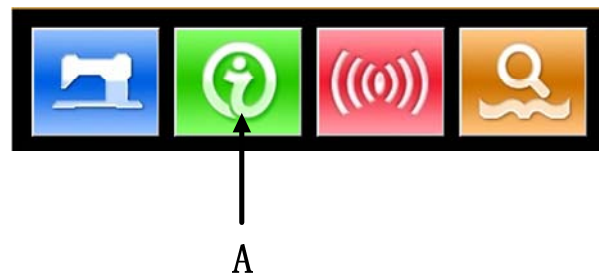

② Display of production control interface

Press the production control interface display key (B) in the information interface to enter the interface of production control (as shown in right figure).

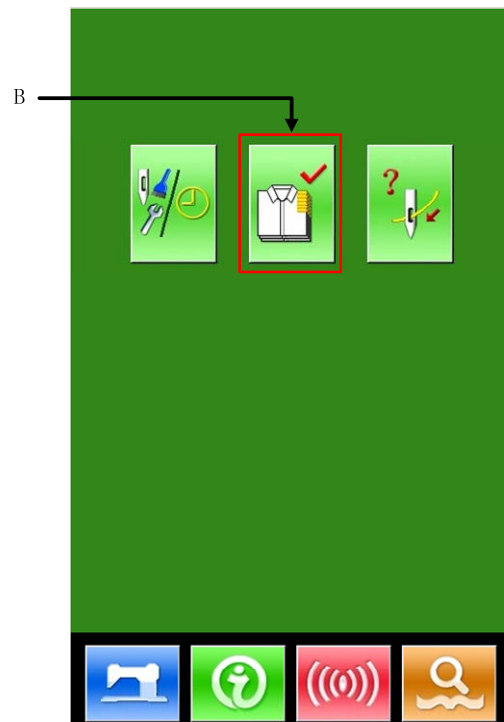

There are five items displayed on the interface of production control as below:

A : Existing Target Value

The number of current target pieces is automatically displayed according to the pitch time.

B : Actual Result Value

The number of the finished pieces is displayed automatically.

C : Final Target Value

Set the final target number of products

D : Pitch Time of Target

Time (second) needed for setting one progress.

E : Unit Interval of Actual

Time actually needed for completing a process.

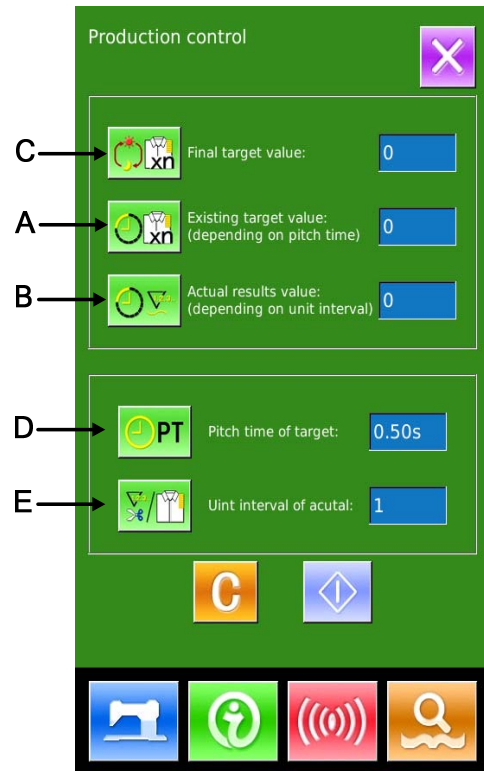

9. 4. 2 Via Sewing Interface

① Display the sewing interface

Press the Ready Key  in the data input interface to show the sewing interface.

② Display the production control interface

Press Information Key (A) in the sewing interface to enter the interface of production control.

The contents displayed and functions are the same to the description in 9.4.1.

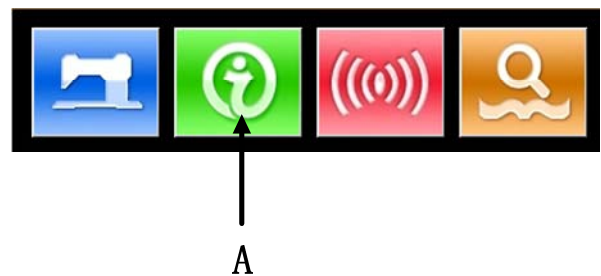

9. 4. 3 Setting of Production Control Information

① Display the production control interface

Press  to display the production control interface

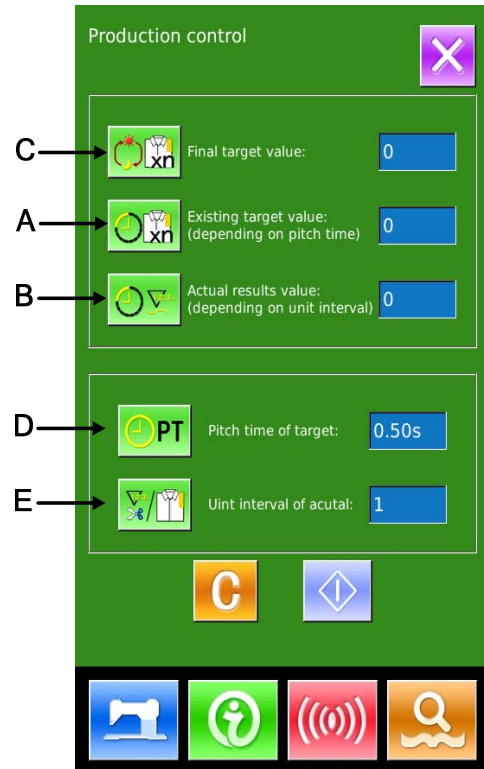



② Input the Final Target Value

At first, please input the number of production target pieces in the process to which sewing is performed from now on. Press the Final Target Value Key

 (C) to enter the interface of final target value.

Press the number keys or the “+” button and “-” button to input the figure you want, and then

press  for confirmation. Press  to quit

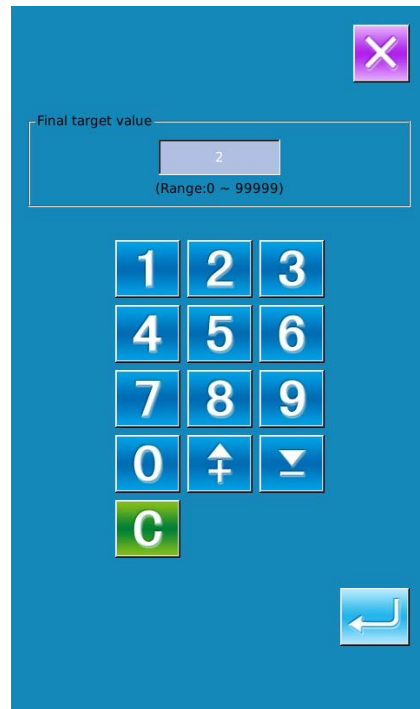



③ **Input Pitch Time**

Then please input the pitch time needed in one

process. Press the Pitch Time Key  (D) in the former page to enter the interface for inputting the pitch time.

Press the number keys or the “+” button and “-“ button to input the figure you want, and then

press  for confirmation. Press  to quit

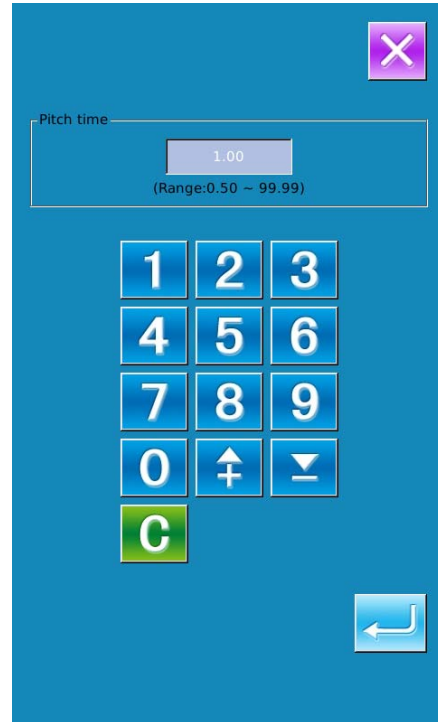



④ **Input the Unit Interval of Actual**

Then we need input the average number of thread trimming in one process. Press the Unit Interval of

Actual  (E) in former page to enter the interface for inputting number of thread trimming.

Press the number keys or the “+” button and “-“ button to input the figure you want, and then

press  for confirmation. Press  to quit

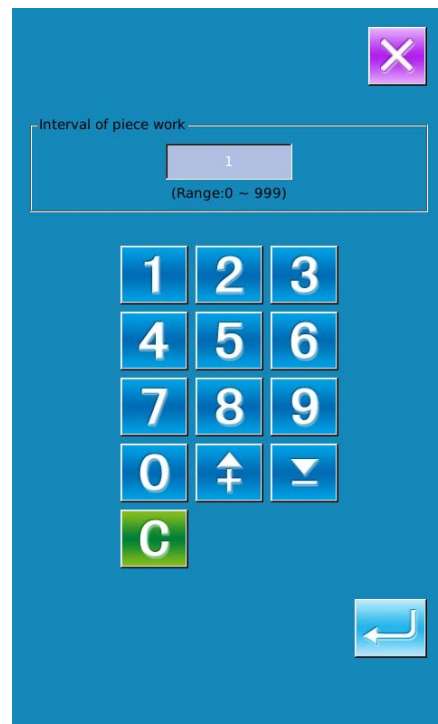

⑤ Start to count number of production pieces

Press  (I); then the **【Final Target Value】** , **【Existing Target Value】** and **【Actual Result Value】** will go dark and the system will start counting the number of the production pieces.



Final Target Value: can be used as the reference of time



Existing Target Value: According to the set value at Pitch Time of Target, the machine begin timing and add one to this value after a set time pitch

Actual Result Value: When entering via “9.4.2 Via Sewing Interface”, the Actual Result Value will start counting according to the value set at **【Unit Interval of Actual】** and add one to this value at each finish of a piece

By setting the Existing Target Value and the Actual Result Value, user can find out whether the productivity of one piece is increased or decreased.

⑥ Stop counting

Under the counting status, the Stop Key  is displayed. Press the Stop Key  to stop counting.

After the counter stops, the Counting Key  is displayed at the position of the Stop Key. If needing to continue counting, please press the Counting Key . The counted value will not be cleared until the Clear

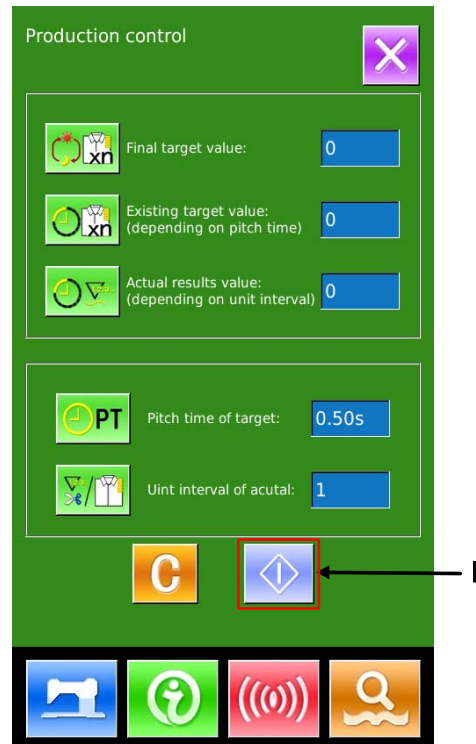

Key  is pressed.

Press  to quit directly





⑦ **Clear the counted value**

When clearing the counted value, make sure the counter is stopped, and then press Clear Key .

The present target value  and the actual value  can be cleared.

(Note: The Clear Key can only be displayed at the counter stopping.)

Press the Clear Key  to enter the interface for confirming the clearing.

In the interface of clearing confirmation, press the  to confirm the clearing. Press  to quit,

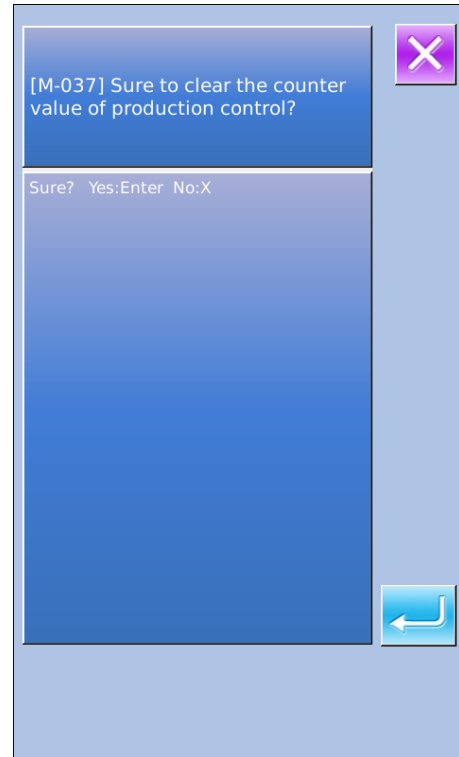

9.5 Threading Figure

In information interface, press  (C) to display the threading figure for your reference.

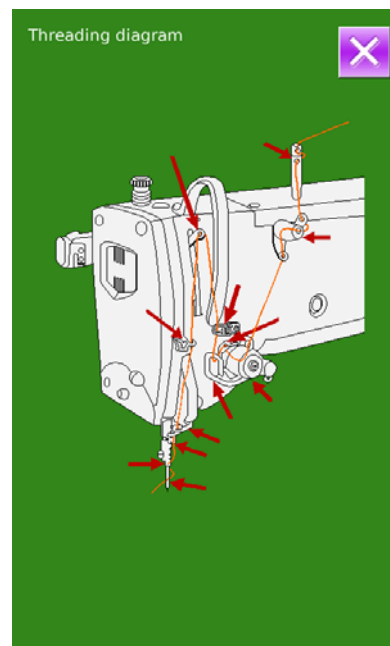
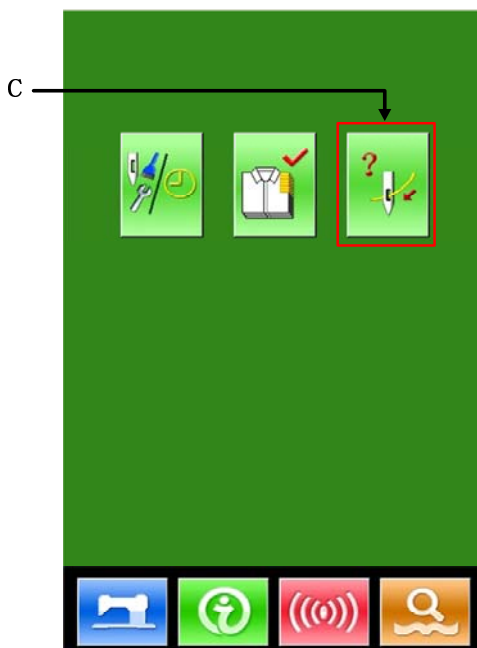

9.6 Warning Record



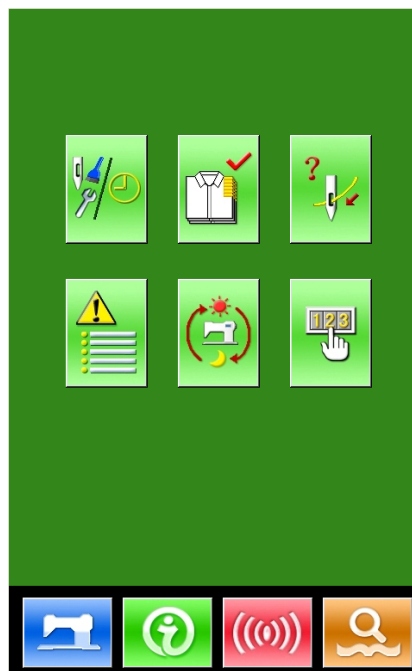

- ① In the interface of maintenance level, press the  to inquire the warning records.



- ② Press  to check the records

As in the picture, the warning information and the times of occurrence are displayed

Function of Keys:

- A、 Press  or  to turn pages
- B、 Press  to quit the inquiry
- C、 Press  to clear the saved record

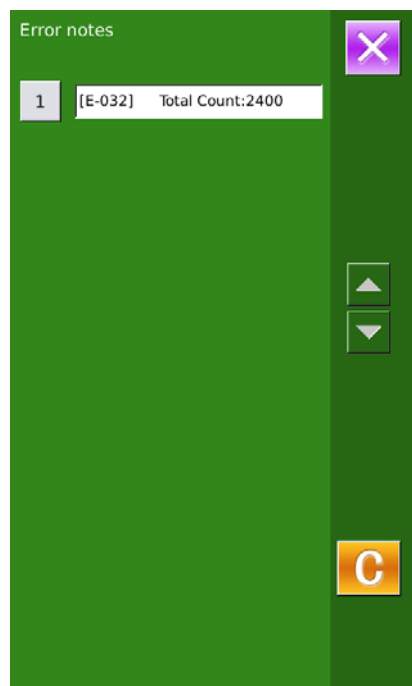

③ Press the number key at the left of the column to display the details of the warning records

Press “ 1 ” to hint the information at right

A、 Press  to quit

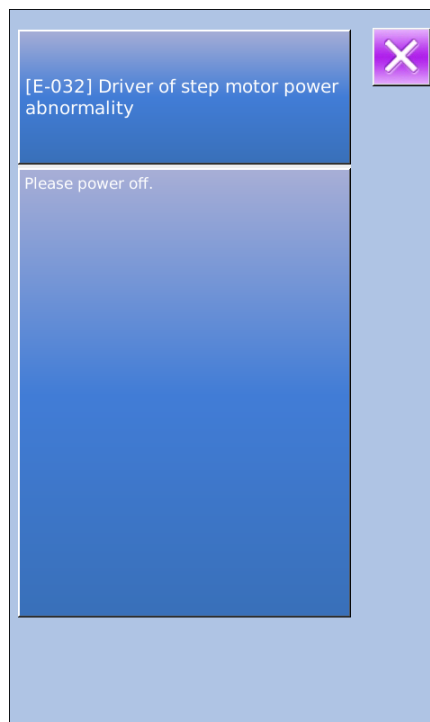

9.7 Running Record

① In the interface of maintenance level, press  to check the running information of the machine.

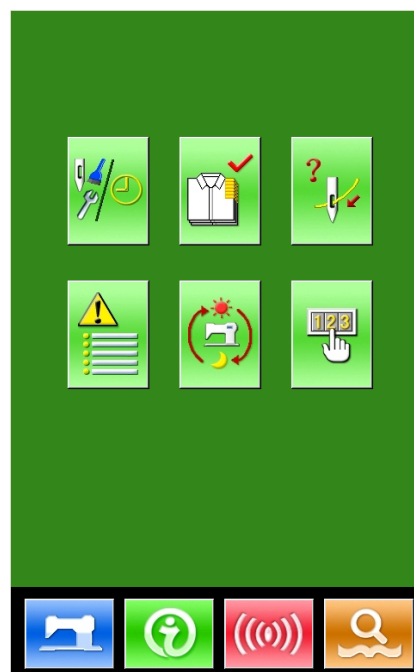

② **The Running records contain:**



: Accumulated running time (Hour)



: Accumulated times for thread trimming



: Accumulated time of power-on (Hour)



: Accumulated number of stitch (1000stitch)

A. Press  to quit

B. Press  to clear the record

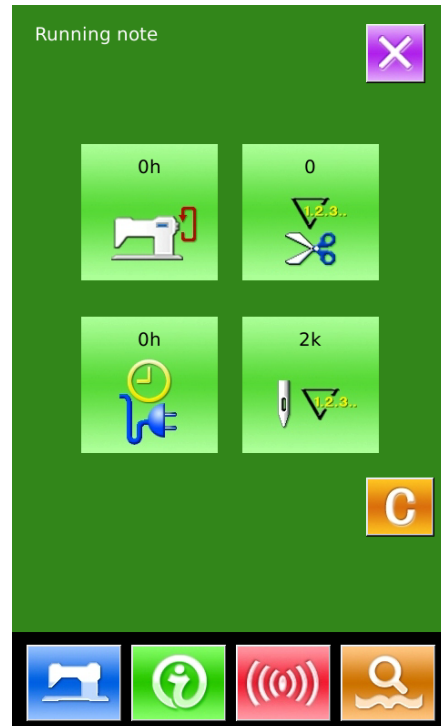

9.8 Setting of Periodical Password

① In maintenance level, Press  to set periodical password

In this interface, the system will ask user to input the User ID. Input the right manufacturer ID to enter the password management mode, where user can set and manage the periodical passwords.

- ◆ At most ten periodical passwords with different activation dates can be set
- ◆ The system will display the information of passwords set by manufacturer.

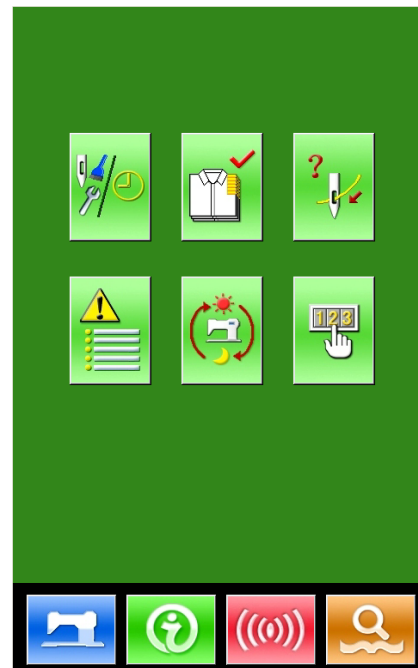

② Press  To input User ID

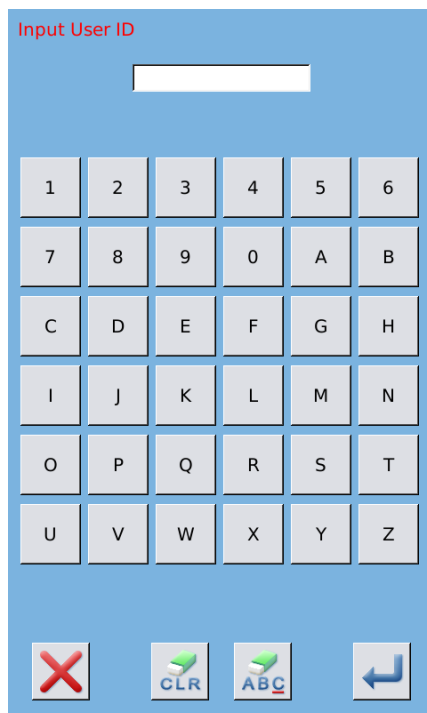

③ **Input the Correct Factory ID to enter the password setting interface**

Procedure for setting the periodical password:

- A、 Continue inputting other periodical passwords

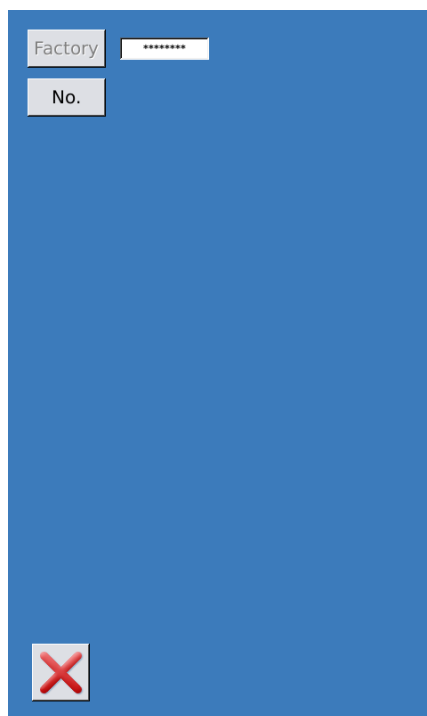

④ **Input Board Number**

Press **【Board Number】** to enter the board number input interface. Input the board number and press



to finish the input

※ **The board is a four-figure number, from 0~9999**

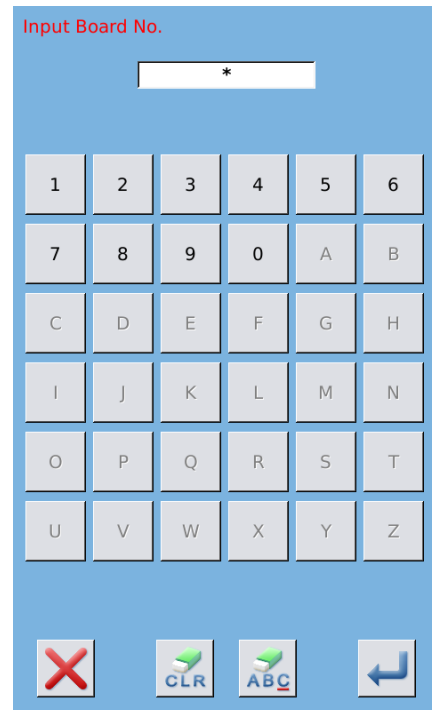

⑤ **Input System Clock**

Press **【Clock】** to enter the interface for setting the system clock. And set the time



⑥ **Input the super password**

Press the **【Super Password】** to enter the interface for setting super password

- ※ **At most, nine super passwords can be input**
- ※ **At the password confirmation, make sure the two input passwords are same**

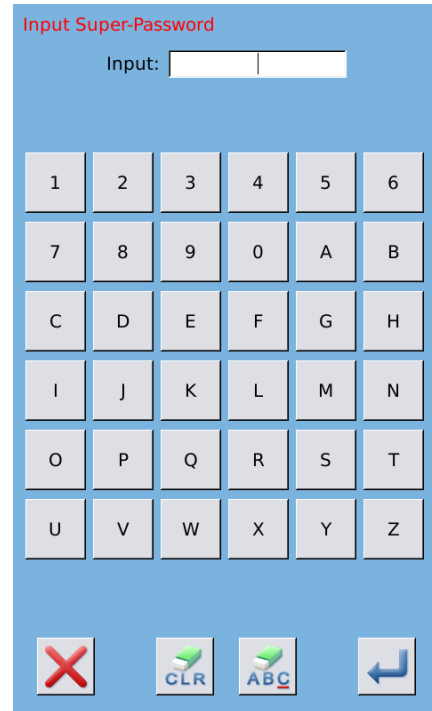

⑦ **Input periodical password**

Press **【Password-1】** to enter the first password date, where user can input the first date for activation. After selecting the proper date, user can press  for confirmation. Then enter the password setting interface to input the password.



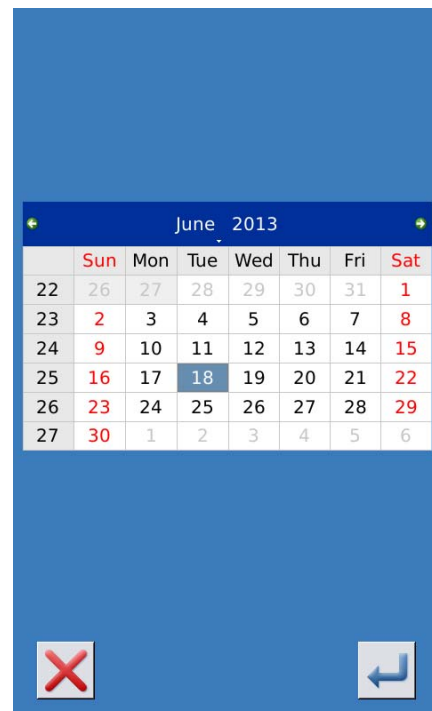

- ※ **The date should not be earlier than the system date**
- ※ **At the password confirmation, make sure the two input passwords are same**



Input Password-1

Input:

1	2	3	4	5	6
7	8	9	0	A	B
C	D	E	F	G	H
I	J	K	L	M	N
O	P	Q	R	S	T
U	V	W	X	Y	Z



   

⑧ **Input other periodical password**

The setting of other periodical password is same to that in step ⑦. Please take the reference to that

※ **The next activation date shall be later than the previous date.**

Factory	*****
No.	0001
Clock	3-05-27 14:39
S-Pw	**
Pw-1	2013-06-18
Pw-2	

 

⑨ Save Password

A、 After inputting the password, please press

 to save it.

B、 After the password is saved, the system will display **【Save the password successfully】** .

Press  to finish the operation and return to the **【main interface of information】** .

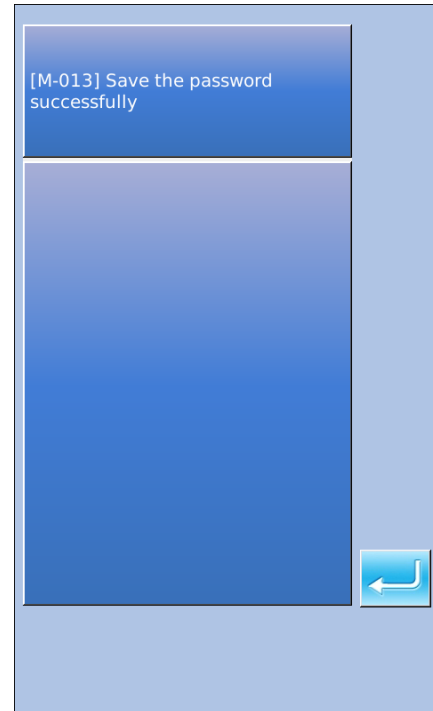

⑩ Clear Password before Activation

It is to clear the passwords before its activation.

A、 The method for entering the password interface is same to that of the password setting

B、 Input the right factory ID to activate the right interface.

C、 The system will display current clock and the activation dates

D、 Press  to delete the password orderly

Input the right periodical password to clear the current password. If the super password is input, all passwords will be cleared;

After the deletion of the password, the date of that password will be displayed in **red**.

If all the passwords are cleared, the system will automatically quit to the main interface of information.

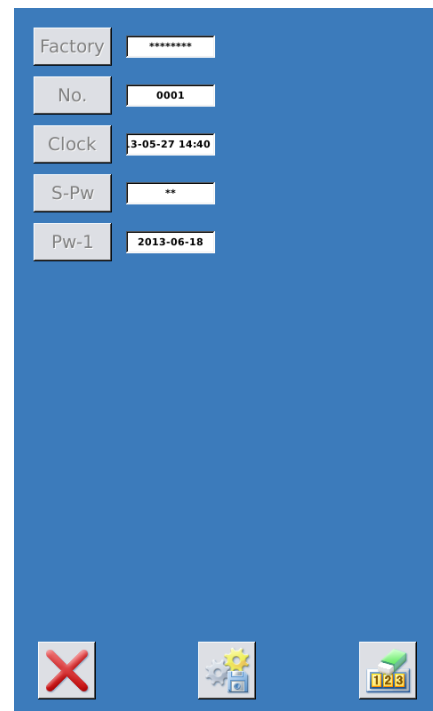

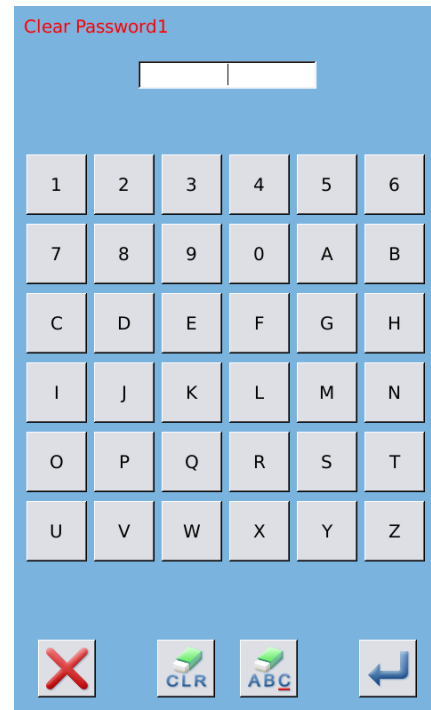

Clear Password at Activation

If the system has password and that password is still effective, it will be activated at the activation day.

If user wants to use the machine he should input the right password.





A、The effective passwords include current password and super password



B、If the current password is input, the current password will be deleted. After user clears the current password, if it is the last password in machine, no more activation of password will happen in future.

C、If the super password is input, all the periodical passwords will be deleted.

10 Appendix 1

10.1 Warning List

No.	Name of Problem	How to recover
E-001	Pedal not at intermediate Position	Self-recovery
E-002	Emergency stop	Press “Reset”
E-004	Main voltage (300V) too low	Turn off Machine
E-005	Main voltage (300V) too high	Self-recovery
E-007	IPM over-voltage or over-current	Turn off machine
E-008	Supplementary device (24V) over-voltage	Turn off machine
E-009	Supplementary device (24V) low-voltage	Turn off machine
E-013	Encoder error or unconnected	Turn off machine
E-014	Motor running error	Turn off machine
E-015	Over sewing range	Turn off machine
E-016	Needle-rod upper position error	Press 
E-017	Thread break detector error	Press 
E-018	Knife position error	Turn off machine
E-019	Emergency stop switch not at proper position	Self-recovery
E-020	Confirmation of tilt of machine head	Turn off machine
E-024	Panel is connected to the machine other than supposed	Turn off machine
E-025	X origin detect error	Turn off machine
E-026	Y origin detect error	Turn off machine
E-027	Presser origin detect error	Turn off machine
E-028	Needle thread trimming origin detect error	Turn off machine
E-029	Bobbin thread trimming origin detect error	Turn off machine
E-030	Step driver communication error	Turn off machine
E-031	Step motor over-current	Turn off machine
E-032	Step driver power supply error	Turn off machine
E-033	Needle-rocking over range	Turn off machine
E-035	Needle thread trimming motor error	Turn off machine
E-036	Bobbin thread trimming motor error	Turn off machine
E-037	Knife can't return	Press 
E-038	Knife sensor error	Turn off machine
E-041	Stepping driver version error	Turn off machine
E-042	Pattern communication error	Press 

No.	Name of Problem	How to recover
E-043	Parameter transfer error	Press 
E-044	Head board EEROM I/O error	Press 
E-254	Undefined error	Press 

10. 2 Hint List

No.	Name	Content
M-001	Set value too large	Please input value within range
M-002	Set value too small	Please input value within range
M-003	Parameter save error	Press Enter to recover default setting
M-004	Communication error	Communication error between operation panel and control box
M-005	Operation head not match to control box	Please check the model and the software version
M-006	Clock error	The hardware clock is down, please contact manufacturer for repair
M-007	Wrong password	Input again
M-008	Wrong user ID	Input again
M-009	Fail to confirm password	Input password again
M-010	Can not change system time	Periodical password has been set, can not change system time
M-011	Password file input error	
M-012	Password file load error	
M-013	Password save successful	
M-014	Clear all password failed	Can not delete password file
M-015	Fail to clear password	After clearance of password, the input of file has problem
M-016	Password file is deleted without authorization	Password file is deleted without authorization, please turn off machine
M-017	Can not input blank	Input password again
M-018	Current password not match	Input current password again
M-019	New password not match	Input new password again
M-020	Periodical password is same to super password error	Input password again
M-021	Enter touching panel correction mode	Are You Sure? Yes: enter No: X
M-022	Correction successful	Correction is successful, please restart machine
M-023	Correction failed	Please perform correction again
M-024	SRAM initialization	Clear all the data within SRAM, please turn off machine and restore the DIP switch
M-025	Turning off	

M-026	No warning record	
M-027	Clear warning record	Are You Sure? Yes: enter No: X
M-028	USB is pulled out	USB is pulled out
M-029	Can not find pattern in U disk	
M-030	Save software version successful	Software version is saved to the root directory of U disk
M-031	Replace needle	Needle replacement set value is reached, please replace needle
M-032	Replace oil	Oil replacement set value is reached, please replace oil
M-033	Clean machine	Cleaning machine set value is reached, please clean machine
M-034	Clear needle replacement set value	Are You Sure? Yes: enter No: X
M-035	Clear oil replacement set value	Are You Sure? Yes: enter No: X
M-036	Clear cleaning time value	Are You Sure? Yes: enter No: X
M-037	Clear production control value	Are You Sure? Yes: enter No: X
M-038	Over sewing range	Please make sure the pattern is within the sewing range
M-039	Stitch number over range	Please reduce patter stitch number
M-040	Load default patterns	No pattern in memory, please load default patterns
M-041	Patter data not exist	Reload or input from pattern-design software
M-042	Pattern data error	Current pattern data error, it will be replaced by default patterns
M-043	Pattern information file open failed	Restore to default pattern configuration
M-044	Pattern is existed	Can not repeat the pattern
M-045	Memory full	Please delete the unused patterns
M-046	Cover the pattern	Are You Sure? Yes: enter No: X
M-047	Continuous sewing pattern open error	Pattern file has mistake, it will be deleted
M-048	Cyclic sewing pattern open error	Pattern file has mistake, it will be deleted
M-049	Delete pattern data	Press Enter to delete; Press ESC to quit
M-050	Delete the selected pattern	Are You Sure? Yes: enter No: X
M-051	Pattern is used, can not delete	Please release the quotation at other pattern type
M-052	Save at least one pattern	Can not delete last pattern
M-053	Number not exist	Input again
M-054	Sewing counter reaches set value	Please pres Enter to cleat it
M-055	No.of pcs counter reaches set value	Please pres Enter to cleat it
M-056	Pattern-designing calculation error	
M-057	Knife size error	
M-058	Sewing code created at pattern-designing error	
M-059	Over max stitch interval	
M-060	Pattern file type error	
M-061	Delete the selected sub-pattern	Are You Sure? Yes: enter No: X
M-062	Delete all sub-patterns	Are You Sure? Yes: enter No: X
M-063	Restore to default setting	Press Enter to perform operation; Press ESC to quit

M-064	EEPROM knife parameter error	Press Enter to recover default setting
M-065	Restore all the settings	Are You Sure? Yes: enter No: X
M-066	Restore the selected items	Are You Sure? Yes: enter No: X
M-067	Not select an item	Please select one or several parameters
M-068	Clear running records	Are You Sure? Yes: enter No: X
M-069	Successful	Current operation is successful
M-070	Failed	Current operation is failed
M-071	Current cyclic sewing pattern is empty or the quoted continuous sewing pattern is empty	Edit again
M-072	Initialize U disk	Press Enter to perform operation; Press ESC to quit. The initialization will delete all the files in U disk
M-073	Initialize memory	Press Enter to perform operation; Press ESC to quit. The initialization will delete all the files in memory
M-074	Please turn off machine	Current operation is finished, please restart machine
M-075	Parameter restoration successful	Parameter restoration successful, please restart machine
M-076	Fail to open file	Fail to open file
M-077	Not select update item	Please select at least one item for update
M-078	Selected item for update is not existed	If the item has no update file, the system will cancel the selection. If user wants to update the rest, please confirm again
M-079	Update successful	Update successful, please restart machine
M-080	Copy failed, please check memory room	Check the room of memory
M-081	Copy failed, please check U Disk	Check whether the U disk is pulled out
M-082	File I/O error	File I/O error
M-083	Verification failed at updating main software	
M-084	Can not delete pattern data	The selected sewing data is in use
M-085	Perform parameter transfer	Are You Sure? Yes: enter No: X
M-086	Can not open changed pattern	Please confirm pattern file
M-087	Changed pattern format error	Please confirm pattern file
M-088	Changed pattern data is too long	Please confirm pattern file
M-089	Pattern-designing data error	EPD parameter is abnormal
M-090	Can not change counter	At changing, please turn off the setting
M-091	Verification failed at updating main software	

10.3 Common Problems and Solutions

No.	Name	Solutions and Steps
E-004	Main voltage too low	1、 Check the input voltage. Make sure it is stable 2、 Check the working condition of main motor
E-005	Main voltage too high	
E-007	IPM over-voltage or over-current	































E-008	Supplementary device (24V) over-voltage	1、	Check the connection of cable L451 (X16 Port Cable on control box);
E-009	Supplementary device (24V) low-voltage	2、	Check needle-thread-trimming motor and bobbin thread-trimming motor
E-013	Encoder error or unconnected	1、	Check the connection of Main motor cables (X4 & X5 Port Cable on control box)
E-014	Motor running error	2、	Make sure the mechanical part is not blocked
E-018	Knife position error	3、	Check the condition of main motor
E-037	Knife can't return	1、	Check mechanical installation. Make sure the knife can return to the origin and the light shield can cover the sensor
E-038	Knife sensor error	2、	Check the connection of L438 Cable
		3、	Check the connection of cable L453 (X9 Port Cable on control box)
		4、	Enter Test Mode and check the working condition of knife sensor. It should display "OFF" at being covered, and "ON" at being exposed
		5、	Check the condition of knife solenoid and the connecting cable. Use parameter K05 to change the working current of knife solenoid. User can check the working condition of it in test mode
E-025	X origin detect error	1、	Check installing position of mechanical devices, especially the sensor. Generally speaking, the distance between the sensor and the shielding sheet should be kept at 3mm;
		2、	Check the cable of the needle-rocking sensor, as well as its connection
		3、	Check the connection of cable L453 (X9 Port Cable on control box);
		4、	Check the needle-rocking motor and its cable connection (X15 Port Cable of Control Box);
		5、	Enter the Test Mode and check the needle-rocking origin sensor. When the needle is at left, the system should display "OFF", while the "ON" at right. Push the needle from right to left or from left to right, and check the change of display. If the display changes more than once, please adjust the installation position.
E-026	Y origin detect error	1、	Check installing position of mechanical devices, especially the sensor. Generally speaking, the distance between the sensor and the shielding sheet should be kept at 3mm;
		2、	Check the cable of the feeding origin sensor, as well as its connection
		3、	Check the connection of cable L453 (X9 Port

		<p>Cable on control box);</p> <p>4、 Check the feeding motor and its cable (X13 Port Cable on control box) , as well as its connection</p> <p>5、 Enter the Input Test Mode and check the feeding origin sensor. When the sensor is covered, the system should display “ON”, while the “OFF” at being exposed.</p>
E-027	Presser origin detect error	<p>1、 Check installing position of mechanical devices, especially the sensor. Generally speaking, the distance between the sensor and the shielding sheet should be kept at 3mm;</p> <p>2、 Check the cable of the presser origin sensor, as well as its connection;</p> <p>3、 Check the connection of cable L453 (X9 Port Cable on control box);</p> <p>4、 Check the presser motor and its cable (X12 Port Cable on control box) , as well as its connection.</p> <p>5、 Enter the Input Test Mode and check the presser origin sensor. When the sensor is covered, the system should display “ON”, while the “OFF” at being exposed.</p>
E-028	Needle thread trimming origin detect error	<p>1、 Check installing position of mechanical devices, especially the sensor. Make sure no blockage in the installation. Generally speaking, the distance between the sensor and the shielding sheet should be kept at 3mm;</p>
E-035	Needle thread trimming motor error	<p>2、 Check the needle-thread-trimming origin sensor. Enter the Input Test Mode; cover the sensor with an iron sheet. The system should display ON at this moment;</p> <p>3、 Check the connection of cable L453 (X9 Port Cable on control box);</p> <p>4、 Check the connection of cable L451;</p> <p>5、 Check the motor and its connecting cables. If the motor has problem, please replace the motor.</p>
E-029	Bobbin thread trimming origin detect error	<p>1、 Check installing position of mechanical devices, especially the sensor. Make sure no blockage in the installation. Generally speaking, the distance between the sensor and the shielding sheet should be kept at 3mm;</p>
E-036	Bobbin thread trimming motor error	<p>2、 Check the bobbin-thread-trimming origin sensor. Enter the Input Test Mode; cover the sensor with an iron sheet. The system should display ON at being covered, while “OFF” at being exposed</p> <p>3、 Check the connection of cable L453 (X9 Port</p>

		<p>Cable on control box)</p> <p>4、 Check the connection of cable L451;</p> <p>5、 Check the motor and its connecting cables. If the motor has problem, please replace the motor.</p>
E-030	Step driver communication error	<p>1、 Check the Connection of the Cable C059-1 (inside control box)</p> <p>2、 Check the software of the stepping driver</p> <p>Note: In sometimes, the system will also give this warning at power-off, it is also normal.</p>
E-031	Step motor over-current	<p>1、 Check needle-rocking motor, feeding motor, presser-lifting motor and knife solenoid. Make sure no blockage at mechanism</p> <p>2、 Repower the machine. If the problem goes still, please replace the board MD301.</p>
E-032	Step driver power supply error	<p>1、 Check the Connection of the Cable H079-1 (inside control box)</p> <p>2、 Check the inlet voltage of X12 port. The normal value is 300V</p>
E-041	Stepping driver version error	Replace the stepping driving software or the MD301 board
E-044	Head board EEROM I/O error	<p>1、 Check the connection of cable L453 (X9 Port Cable on control box). If the cable has problem, please replace that cable</p> <p>2、 If the cable is ok, please replace SC041 board</p>
M-004	Communication error	Check the connection of cable between operation panel and control box (X7 Port Cable on control box)
M-005	Operation head not match to control box	Replace the proper control box software or the operation head software

10. 4 Default Values of Sewing Shapes















The following are the Default Values of sewing shape

No.	Item	Unit															
S01	Sewing Shape	mm															
S02	Length of cloth cutting	mm	12.7	12.7	12.7	12.7	12.7	12.7	12.7	12.7	12.7	12.7	12.7	12.7	12.7	12.7	12.7
S03	Knife groove width, right	mm	0.10	0.10	0.10	0.10	0.10	0.10	0.10	0.10	0.10	0.10	0.10	0.10	0.10	0.10	0.10
S04	Knife groove width, left	mm	0.10	0.10	0.10	0.10	0.10	0.10	0.10	0.10	0.10	0.10	0.10	0.10	0.10	0.10	0.10
S05	Over-edging width, left	mm	1.70	1.70	1.70	1.70	1.70	1.70	1.40	1.40	1.40	1.40	1.70	1.70	1.70	1.70	1.70
S06	Ratio of right and left shapes	%	100	100	100	100	100	100	100	100	100	100	100	100	100	100	100
S07	Pitch at parallel section	mm	0.35	0.35	0.35	0.35	0.35	0.35	0.35	0.35	0.35	0.35	0.35	0.35	0.35	0.35	0.35
S08	2nd bar-tacking length	mm	1.0	—	1.0	—	1.5	3.0	1.0	—	1.5	3.0	—	1.0	1.0	1.5	3.0
S09	1st bar-tacking length	mm	1.0	—	—	—	—	—	—	—	—	—	—	—	—	—	—
S10	Compensation of bar-tacking width, right	mm	0	—	0	—	0	—	0	—	0	—	—	0	0	0	—
S11	Compensation of bar-tacking width, left	mm	0	—	0	—	0	—	0	—	0	—	—	0	0	0	—
S12	Left Taper Bar-tacking	mm	—	—	—	—	—	0.85	—	—	—	0.85	—	—	—	—	0.85
S13	Right Taper Bar-tacking	mm	—	—	—	—	—	0.85	—	—	—	0.85	—	—	—	—	0.85
S14	Eyelet shape length	mm	—	—	—	—	—	—	2.0	2.0	2.0	2.0	—	—	—	—	—
S15	Number of stitches of eyelet shape	Stitch	—	—	—	—	—	—	3	3	3	3	—	—	—	—	—
S16	Eyelet width	mm	—	—	—	—	—	—	1.0	1.0	1.0	1.0	—	—	—	—	—
S17	Eyelet length	mm	—	—	—	—	—	—	3.0	3.0	3.0	3.0	—	—	—	—	—
S18	Round type shape length	mm	—	2.0	2.0	2.0	2.0	2.0	—	2.0	—	—	2.0	2.0	2.0	2.0	2.0
S19	Number of radial shape stitches	Stitch	—	—	3	3	3	3	—	3	—	—	—	—	—	—	—
S20	Radial bar-tacking	—	—	—	No	No	No	No	—	No	—	—	—	—	—	—	—
S21	Pitch at bar-tacking section	mm	0.30	0.30	0.30	-	0.30	0.30	0.30	-	0.30	0.30	0.25	0.30	0.25	0.25	0.25
S22	1 st clearance	mm	1.5	1.5	1.5	1.5	1.5	1.5	1.5	1.5	1.5	1.5	1.5	1.5	1.5	1.5	1.5
S23	2nd clearance	mm	1.3	1.3	1.3	1.3	1.3	1.3	1.3	1.3	1.3	1.3	1.3	1.3	1.3	1.3	1.3

S31	Single/ Double Sewing	—	Single	Single	Single	Single	Single	Single	Single	Single	Single	Single	Single	Single	Single	Single	Single
S32	Select Cross at Double Sewing	—	<	<	<	<	<	<	<	<	<	<	<	<	<	<	<
S33	Compensation of Double Sewing Width	mm	0	0	0	0	0	0	0	0	0	0	0	0	0	0	0
S34	Number of Basting Times	Time	0	0	0	0	0	0	0	0	0	0	0	0	0	0	0
S35	Basting Pitch	mm	4.0	4.0	4.0	4.0	4.0	4.0	4.0	4.0	4.0	4.0	4.0	4.0	4.0	4.0	4.0
S36	Rolling Length of Basting	mm	8.0	8.0	8.0	8.0	8.0	8.0	8.0	8.0	8.0	8.0	8.0	8.0	8.0	8.0	8.0
S37	Rolling Pitch of Basting	mm	0.8	0.8	0.8	0.8	0.8	0.8	0.8	0.8	0.8	0.8	0.8	0.8	0.8	0.8	0.8
S38	Rolling Width of Basting	mm	1.5	1.5	1.5	1.5	1.5	1.5	1.5	1.5	1.5	1.5	1.5	1.5	1.5	1.5	1.5
S39	Lengthwise Compensation of Needle Entry at Basting	mm	1.5	1.5	1.5	1.5	1.5	1.5	1.5	1.5	1.5	1.5	1.5	1.5	1.5	1.5	1.5
S40	Horizontal Compensation of Needle Entry at Basting	mm	0	0	0	0	0	0	0	0	0	0	0	0	0	0	0
S41	Compensation of Left Side Position at Basting	mm	0	0	0	0	0	0	0	0	0	0	0	0	0	0	0
S42	Compensation of Right Side Position at Basting	mm	0	0	0	0	0	0	0	0	0	0	0	0	0	0	0
S44	Basting Speed	mm	2000	2000	2000	2000	2000	2000	2000	2000	2000	2000	2000	2000	2000	2000	2000
S45	Pair-sewing	—	No	No	No	No	No	No	No	No	No	No	No	No	No	No	No
S46	Pair-sewing Width	mm	2.0	2.0	2.0	2.0	2.0	2.0	2.0	2.0	2.0	2.0	2.0	2.0	2.0	2.0	2.0
S47	Pair-sewing Pitch	mm	2.0	2.0	2.0	2.0	2.0	2.0	2.0	2.0	2.0	2.0	2.0	2.0	2.0	2.0	2.0
S51	Left Parallel Tension	—	60	60	60	60	60	60	60	60	60	60	60	60	60	60	60
S52	Right Parallel Tension	—	60	60	60	60	60	60	60	60	60	60	60	60	60	60	60
S53	Left Parallel Tension (1 st lap at double sewing)	—	60	60	60	60	60	60	60	60	60	60	60	60	60	60	60
S54	Right Parallel Tension (1 st lap at double sewing)	—	60	60	60	60	60	60	60	60	60	60	60	60	60	60	60

S55	1 st Bar-tacking Tension	—	35	60	120	35	35	35	60	60	60	60	60	60	60	60	60
S56	2 nd Bar-tacking Tension	—	35	60	35	35	35	35	60	60	60	60	60	60	60	60	606
S57	Set Needle Thread Tension at Sewing Start	—	25	25	25	25	25	25	25	25	25	25	25	25	25	25	25
S58	Set the Needle Thread Tension at Basting	—	80	80	80	80	80	80	80	80	80	80	80	80	80	80	80
S59	ACT Timing Adjustment at 1st Bar-tacking Start	Stitch	0	0	0	0	0	0	0	0	0	0	0	0	0	0	0
S60	ACT Timing Adjustment at Right Over-edging Start	Stitch	0	0	0	0	0	0	0	0	0	0	0	0	0	0	0
S61	ACT Timing Adjustment at 2nd Bar-tacking Start	Stitch	0	0	0	0	0	0	0	0	0	0	0	0	0	0	0
S62	Bar-tacking Stitch Number at Sewing Start	Stitch	3	3	3	3	3	3	3	3	3	3	3	3	3	3	3
S63	Bar-tacking Pitch at Sewing Start	-	0	0	0	0	0	0	0	0	0	0	0	0	0	0	0
S64	Bar-tacking Width at Sewing Start	mm	0.6	0.6	0.6	0.6	0.6	0.6	0.6	0.6	0.6	0.6	0.6	0.6	0.6	0.6	0.6
S65	Vertical Adjustment of Bar-Tacking Sewing at Sewing Start	mm	0	1.5	0	1.5	0	0	0	1.5	0	0	1.5	0	0	0	0
S66	Horizontal Adjustment of Bar-Tacking Sewing at Sewing Start	mm	0	0	0	0	0	0.7	0	0	0	0.7	0	0	0	0	0.7
S67	Bar-tacking Width at Sewing End	mm	0.6	0.6	0.6	0.6	0.6	0.6	0.6	0.6	0.6	0.6	0.6	0.6	0.6	0.6	0.6
S68	Bar-tacking Stitch Number at Sewing End	Stitch	3	3	3	3	3	3	3	3	3	3	3	3	3	3	3
S69	Vertical Adjustment of Bar-Tacking Sewing at Sewing End	mm	0	0	0	0	0	0	0	0	0	0	0	0	0	0	0

S70	Horizontal Adjustment of Bar-Tacking Sewing at Sewing End	mm	0.9	0.9	0.9	0.9	0	0.7	0.9	0.9	0	0.7	0.9	0.9	0.9	0	0.7
S81	Knife motion	—	Yes	Yes	Yes	Yes	Yes	Yes	Yes	Yes	Yes	Yes	Yes	Yes	Yes	Yes	Yes
S83	Knife motion at 1st lap of double stitching	—	No	No	No	No	No	No	No	No	No	No	No	No	No	No	No
S84	Max Speed Limitation	rpm	3600	3600	3600	3600	3600	3600	3600	3600	3600	3600	3600	3600	3600	3600	3600
S86	Pitch of Forward	mm															
S87	Width of Forward	mm															
S88	Pitch of Return	mm															
S89	Width of Return	mm															

No.	Item	Unit																
S01	Sewing Shape	mm																
S02	Length of cloth cutting	mm	12.7	12.7	12.7	12.7	12.7	12.7	12.7	12.7	12.7	12.7	12.7	12.7	13	19.1	19.1	19.1
S03	Knife groove width, right	mm	0.10	0.10	0.10	0.10	0.10	0.10	0.10	0.10	0.10	0.10	0.10	0.10	—	—	0.10	0.10
S04	Knife groove width, left	mm	0.10	0.10	0.10	0.10	0.10	0.10	0.10	0.10	0.10	0.10	0.10	0.10	—	0.10	—	0.10
S05	Over-edging width, left	mm	1.40	1.40	1.70	1.70	1.70	1.70	1.70	1.70	1.70	1.70	1.70	1.70	—	—	—	—
S06	Ratio of right and left shapes	%	100	100	100	100	100	100	100	100	100	100	100	100	—	—	—	—
S07	Pitch at parallel section	mm	0.35	0.35	0.35	0.35	0.35	0.35	0.35	0.35	0.35	0.35	0.35	0.35	—	—	—	—
S08	2nd bar-tacking length	mm	—	—	—	—	—	1.5	3.0	—	—	—	—	—	—	—	—	—
S09	1st bar-tacking length	mm	—	—	1.0	1.0	1.0	1.0	1.0	—	—	—	—	—	—	—	—	—
S10	Compensation of bar-tacking width, right	mm	—	—	0	0	0	0	0	—	—	—	—	—	—	—	—	—
S11	Compensation of bar-tacking width, left	mm	—	—	0	0	0	0	0	—	—	—	—	—	—	—	—	—
S12	Left Taper Bar-tacking	mm	—	—	—	—	—	—	0.85	—	—	—	—	—	—	—	—	—
S13	Right Taper Bar-tacking	mm	—	—	—	—	—	—	0.85	—	—	—	—	—	—	—	—	—

S14	Length of Eyelet buttonhole	mm	2.0	2.0	—	—	—	—	—	—	—	—	—	—	—	—	—
S15	Number of stitches of eyelet shape	针	3	3	—	—	—	—	—	—	—	—	—	—	—	—	—
S16	Eyelet width	mm	1.0	1.0	—	—	—	—	—	—	—	—	—	—	—	—	—
S17	Eyelet shape length	mm	3.0	3.0	—	—	—	—	—	—	—	—	—	—	—	—	—
S18	Round type shape length	mm	2.0	2.0	2.0	2.0	2.0	—	—	2.0	2.0	2.0	2.0	—	—	—	—
S19	Number of radial shape stitches	Stitch	—	—	3	—	—	—	—	3	3	3	—	—	—	—	—
S20	Radial bar-tacking	—	—	—	No	—	—	—	—	No	No	NO	—	—	—	—	—
S21	Pitch at bar-tacking section	mm	0.25	0.30	0.30	0.25	0.30	0.30	0.30	0.25	0.30	0.25	0.25	—	—	—	—
S22	1 st clearance	mm	1.5	1.5	1.5	1.5	1.5	1.5	1.5	1.5	1.5	1.5	1.5	—	2.0	2.0	2.0
S23	2nd clearance	mm	1.3	1.3	1.3	1.3	1.3	1.3	1.3	1.3	1.3	1.3	1.3	—	2.0	2.0	2.0
S31	Single/ Double Sewing	—	Single	Single	Single	Single	Single	Single	Single	Single	Single	Single	Single	—	—	—	Single
S32	Select Cross at Double Sewing	—	<	<	<	<	<	<	<	<	<	<	<	—	—	—	<
S33	Compensation of Double Sewing Width	mm	0	0	0	0	0	0	0	0	0	0	0	—	—	—	—
S34	Number of Basting Times	Time	0	0	0	0	0	0	0	0	0	0	0	3	2	2	—
S35	Basting Pitch	mm	4.0	4.0	4.0	4.0	4.0	4.0	4.0	4.0	4.0	4.0	4.0	4.0	4.0	4.0	4.0
S36	Rolling Length of Basting	mm	8.0	8.0	8.0	8.0	8.0	8.0	8.0	8.0	8.0	8.0	8.0	8.0	8.0	8.0	8.0
S37	Rolling Pitch of Basting	mm	0.8	0.8	0.8	0.8	0.8	0.8	0.8	0.8	0.8	0.8	0.8	0.8	0.8	0.8	0.8
S38	Rolling Width of Basting	mm	1.5	1.5	1.5	1.5	1.5	1.5	1.5	1.5	1.5	1.5	1.5	1.5	1.5	1.5	1.5
S39	Lengthwise Compensation of Needle Entry at Basting	mm	1.5	1.5	1.5	1.5	1.5	1.5	1.5	1.5	1.5	1.5	1.5	1.5	1.5	1.5	1.5
S40	Horizontal Compensation of Needle Entry at Basting	mm	0	0	0	0	0	0	0	0	0	0	0	0	0	0	0
S41	Compensation of Left Side Position at Basting	mm	0	0	0	0	0	0	0	0	0	0	0	0	0	0	0
S42	Compensation of	mm	0	0	0	0	0	0	0	0	0	0	0	0	0	0	0

	Right Side Position at Basting																	
S44	Basting Speed	mm	2000	2000	2000	2000	2000	2000	2000	2000	2000	2000	2000	2000	2000	2000	2000	—
S45	Pair-sewing	—	No	No	No	No	No	No	No	No	No	No	—	—	—	—	—	—
S46	Pair-sewing Width	mm	2.0	2.0	2.0	2.0	2.0	2.0	2.0	2.0	2.0	2.0	2.0	—	—	—	—	—
S47	Pair-sewing Pitch	mm	2.0	2.0	2.0	2.0	2.0	2.0	2.0	2.0	2.0	2.0	2.0	—	—	—	—	—
S51	Left Parallel Tension	—	60	60	60	60	60	60	60	60	60	60	60	60	60	60	60	60
S52	Right Parallel Tension	—	60	60	60	60	60	60	60	60	60	60	60	60	60	60	60	60
S53	Left Parallel Tension (1 st lap at double sewing)	—	60	60	60	60	60	60	60	60	60	60	60	60	—	—	—	—
S54	Right Parallel Tension (1 st lap at double sewing)	—	60	60	60	60	60	60	60	60	60	60	60	60	—	—	—	—
S55	1 st Bar-tacking Tension	—	60	60	60	60	60	60	60	60	60	60	60	60	—	—	—	—
S56	2 nd Bar-tacking Tension	—	60	60	60	60	60	60	60	60	60	60	60	60	—	—	—	—
S57	Set Needle Thread Tension at Sewing Start	—	25	25	25	25	25	25	25	25	25	25	25	25	25	25	25	25
S58	Set the Needle Thread Tension at Basting	—	80	80	80	80	80	80	80	80	80	80	80	80	80	80	80	80
S59	ACT Timing Adjustment at 1st Bar-tacking Start	Stitch	0	0	0	0	0	0	0	0	0	0	0	0	—	—	—	—
S60	ACT Timing Adjustment at Right Over-edging Start	Stitch	0	0	0	0	0	0	0	0	0	0	0	0	0	0	0	0
S61	ACT Timing Adjustment at 2nd Bar-tacking Start	Stitch	0	0	0	0	0	0	0	0	0	0	0	0	—	—	—	—
S62	Bar-tacking Stitch Number at Sewing Start	Stitch	3	3	3	3	3	3	3	3	3	3	3	3	3	3	3	3
S63	Bar-tacking Pitch at Sewing Start	-	0	0	0	0	0	0	0	0	0	0	0	0	0	0	0	0
S64	Bar-tacking Width at Sewing Start	mm	0.6	0.6	0.6	0.6	0.6	0.6	0.6	0.6	0.6	0.6	0.6	0.6	0.6	0.6	0.6	0.6
S65	Vertical Adjustment of Bar-Tacking	mm	1.5	1.5	1.5	1.5	1.5	0	0	1.5	1.5	1.5	1.5	0	0	0	0	0

	Sewing at Sewing Start																
S66	Horizontal Adjustment of Bar-Tacking Sewing at Sewing Start	mm	0	0	0	0	0	0	0.7	0	0	0	0	0	0	0	0
S67	Bar-tacking Width at Sewing End	mm	0.6	0.6	0.6	0.6	0.6	0.6	0.6	0.6	0.6	0.6	0.6	0.6	0.6	0.6	0.6
S68	Bar-tacking Stitch Number at Sewing End	Stitch	3	3	3	3	3	3	3	3	3	3	3	3	3	3	3
S69	Vertical Adjustment of Bar-Tacking Sewing at Sewing End	mm	0	0	0	0	0	0	0	0	0	0	0	0	0	0	0
S70	Horizontal Adjustment of Bar-Tacking Sewing at Sewing End	mm	0.9	0.9	0.9	0.9	0.9	0	0.7	0.9	0.9	0.9	0.9	0.9	0	0	0
S81	Knife motion	—	Yes	Yes	Yes	Yes	Yes	Yes	Yes	Yes	Yes	Yes	Yes	Yes	—	Yes	Yes
S83	Knife motion at 1st lap of double stitching	—	No	No	No	No	No	No	No	No	No	No	No	No	—	—	—
S84	Max Speed Limitation	rpm	3600	3600	3600	3600	3600	3600	3600	3600	3600	3600	3600	3600	3600	3600	3600
S86	Pitch of Forward	mm												0.80	0.80	0.80	0.80
S87	Width of Forward	mm												1.7	1.7	1.7	1.7
S88	Pitch of Return	mm												0.80	0.80	0.80	0.80
S89	Width of Return	mm												1.7	1.7	1.7	1.7

11 Appendix 2

11.1 Installation Size of Control Box

At present, there are two installation types for the controller, which are 4-hole installation and 3-hole installation. Please refer to the picture at below for the detailed size:

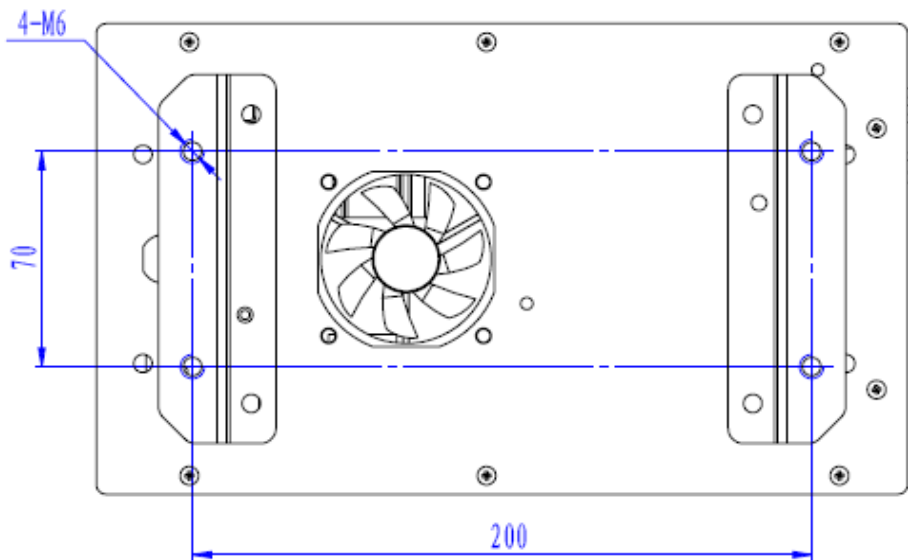

Figure 1 4-hole Installation

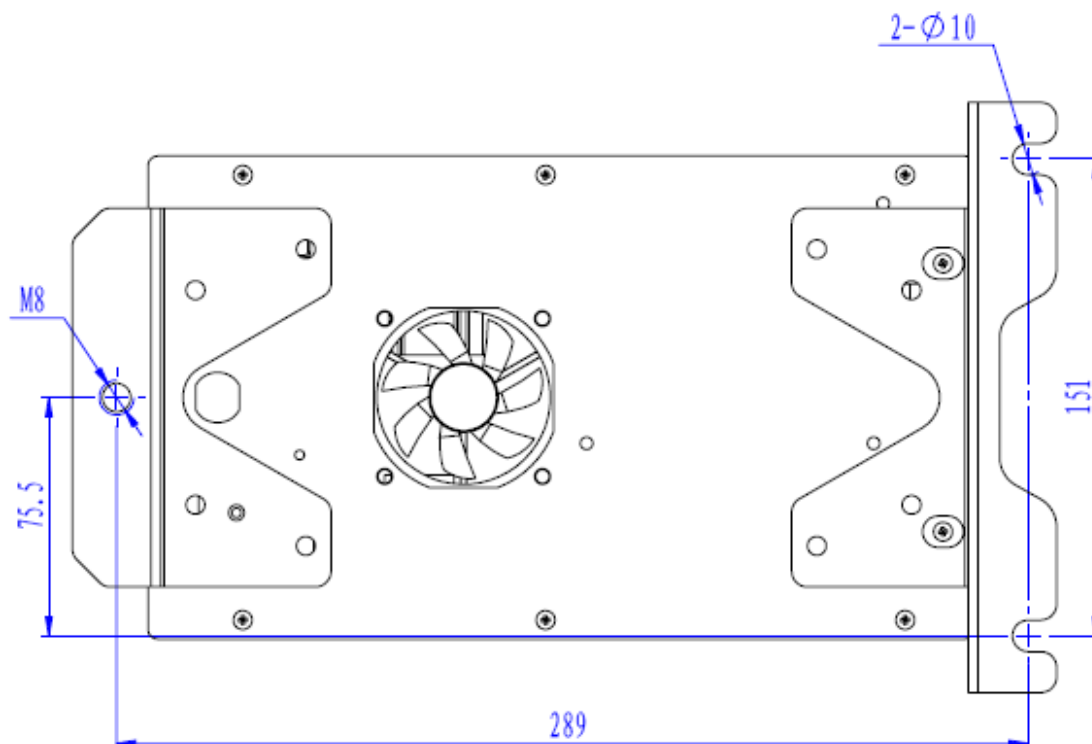

Figure 2 3-hole Installation

11.2 Installation Size of Operation Panel

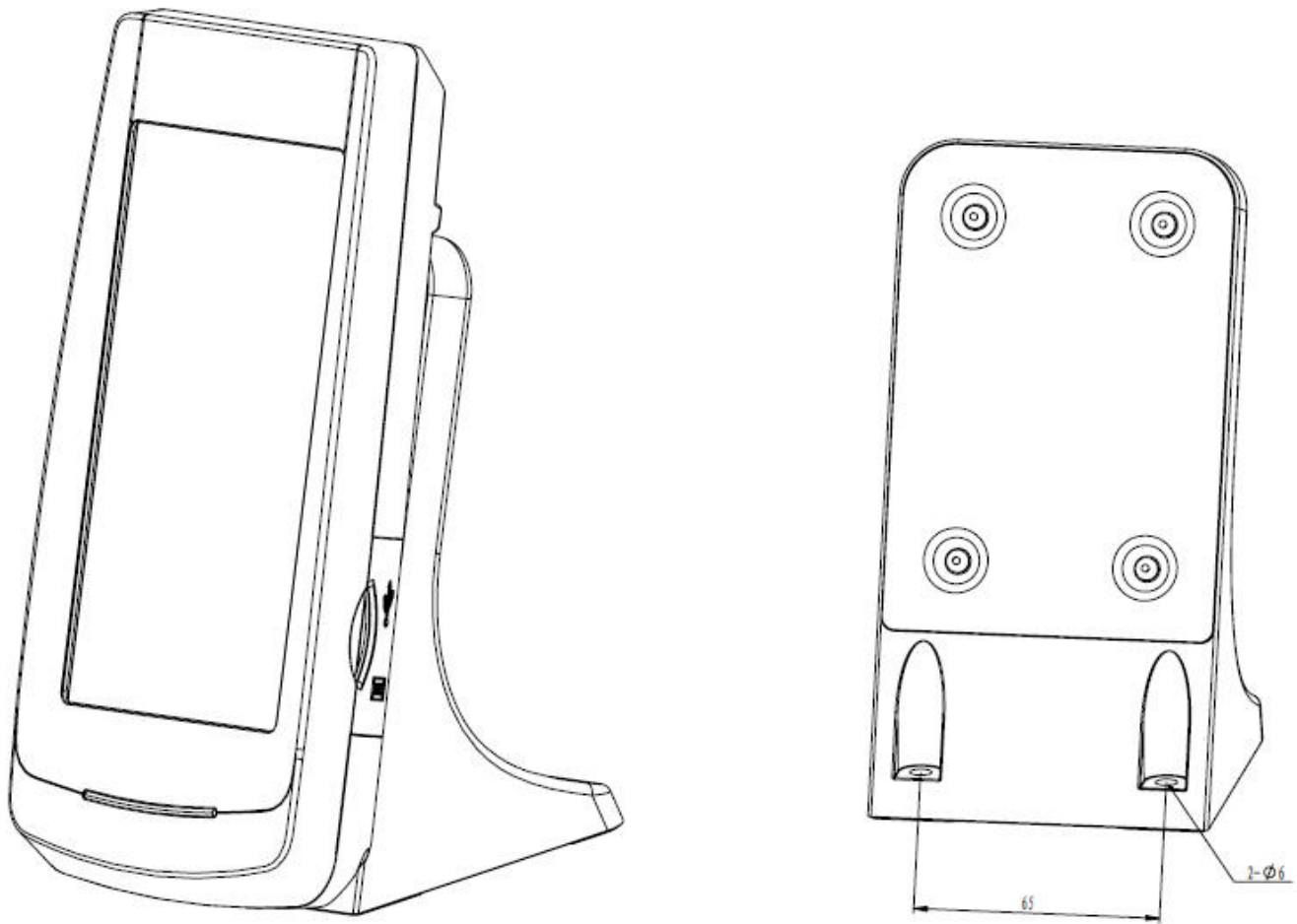

Figure 3 Installation Size of Operation Panel

12.3 System Diagram

